

M E L J A C ■

*PRICE LIST IN EUROS (€)*

2024

Validity 03/31/2025

Due to the current increase in raw materials, MELJAC reserves the right to modify, without notice, the period of validity of its prices. Please contact us.

[www.meljac.com](http://www.meljac.com)



**CLASSIQUE**

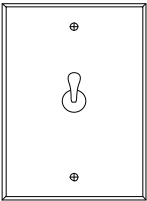

p. 2

**ELLIPSE**

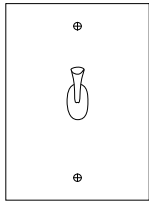

p. 19

**DAMIER**

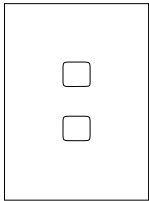

p. 26

**CANNELÉE**

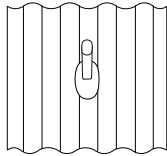

p. 28

**SOLARIS**



p. 31

**TOURNAIRE**

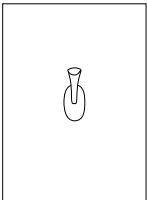

p. 35

**STUDIO**

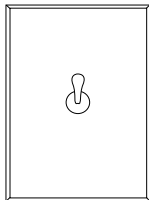

p. 37

**SOL**

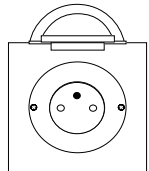

p. 39

**VOLUMES**

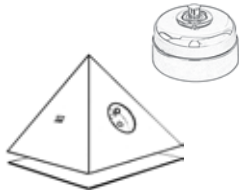

p. 42

**PIERROT**

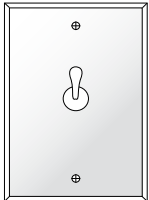

p. 47

**PLEXIGLASS**



p. 49

**LIMOGES**

CLASSIQUE  
ELLIPSE

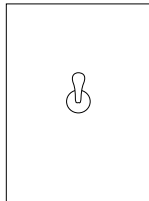

p. 51

**CRESTRON CONNECTED**

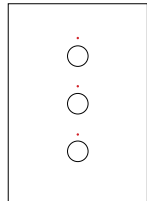

p. 55

**SPOTS**

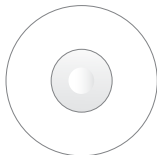

p. 57

**TECHNICAL INFORMATION**

Finishes  
Options  
p. 59

Mécanismes  
Back boxes  
Screwless system  
p. 70

## Characteristics of the collections

	Controls elements				Materials and thickness						Edges			Screws	
					Brass			Glass	Plexiglass	Porcelain					
	V&V	Inv auto	BP	BPE	3mm	5,5mm	6mm	4mm	3mm	3mm	Chamfer	Straight	Special	With screws	Screwless
Classique	✓	✓	✓	✓	✓						✓	UR	UR	✓	Option
Ellipse	✓	✓	✓		✓						UR	✓	UR	✓	Option
Damier			✓		✓						UR	✓	UR	UR	✓
Cannelée	✓	✓	✓			✓							✓		✓
Solaris	✓	✓	✓		✓								✓		✓
Tournaire	✓	✓	✓				✓						✓		✓
Studio	✓	✓	✓		✓						✓	UR			✓
Sol							✓					✓			✓
Pierrot	✓	✓	✓	✓				✓			✓			✓	
Plexiglass	✓	✓	✓	✓					✓		✓			✓	

UR : upon request

# CLASSIQUE COLLECTION

## SPECIFICATIONS

### General

- Switches, reading lamps and sockets
- Protection index: IP20 (*IP21 on request*)
- Products must be installed indoors and earthed (*except for low current*)
- Cleaning only with a soft and dry duster, no product

### Covering plate

- Solid brass 3mm thick
- With chamfer and visible screws
- **Screwless option available for some models – please contact us. Prices for backplates – p. 72**
- Finishes: Nickel, Chrome, Bronze médaille, Cuivre, Doré, Canon de fusil... (*p.59*)

### Control mechanisms

- Round base - Droplet lever or push button
- Chrome-plated on cold and special finishes, golden on warm finishes
- Automatic connection by default, screw connection on request

## SIZES & BACK BOXES

Sizes (in mm)	Recommended back boxes
Ø98 - 80x80 - 115x80 - 142x80 205x80 - 267x80	Mixed MELJAC, for dry partition and masonry
38x91 - 38x133 - 38x175	Narrow MELJAC, for masonry only
56x56 - Ø56	LEGRAND 89246, for masonry only
Oval - Hexagonal - Octagonal	LEGRAND 80051, for dry partition only

Renovation: can be adapted for other boxes: please contact us

### How to fix?

The covering plate is directly screwed onto the back box.

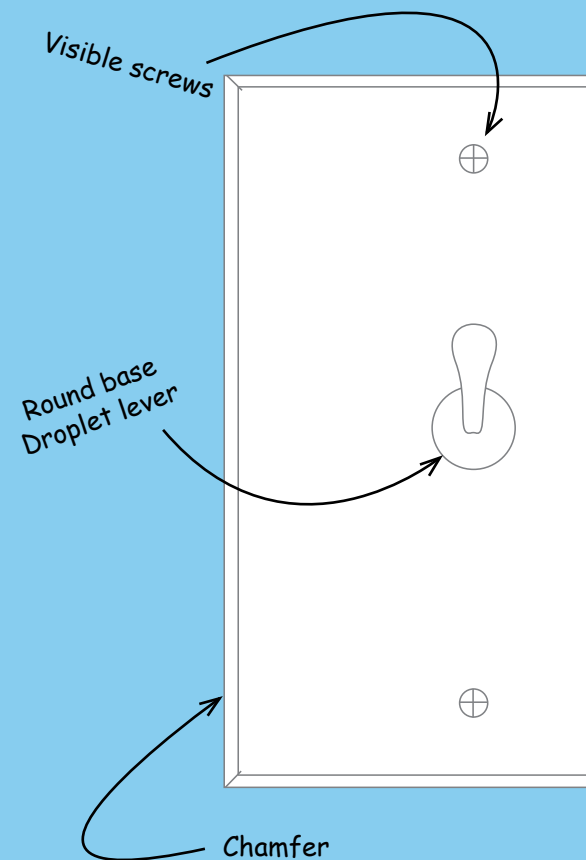

ORIGINE  
FRANCE®  
GARANTIE

BVCert. 6012053

# CLASSIQUE

Diagrams	Back box colour	Size (mm)	Fittings	Reference	Cold finishes	Warm finishes	Special finishes	Shiny Gilding
		80x80x3	1 control element	FC3008A-A1100010	92,35	96,97	110,82	132,98
			2 control elements	FC3008A-A1100021	114,42	120,14	137,30	164,76
		80x80x3	1 Electronic Dimmer NU3514	FC3008A-K1000024	300,00	315,00	360,00	432,00
			1 Universal Dimmer S520519	FC3008A-K1000022	232,15	243,76	278,57	334,28
		80x80x3	Ambiant thermostat Legrand 76720	FC3008A-K1000120	535,00	561,75	641,99	770,39
			Ambiant thermostat Legrand 76720 with heat/cold selector	FC3008A-K1000124				
		80x80x3	Floor thermostat Schneider S520507	FC3008A-K1000126	433,98	455,68	520,78	624,94
			Thermostat Schneider S520509	FC3008A-K1000127	459,34	482,30	551,20	661,44

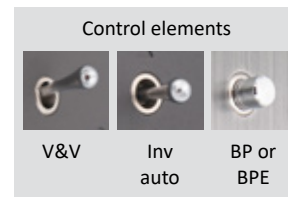

## Control elements examples with options

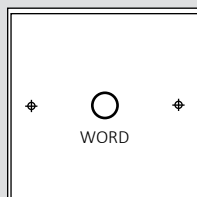

Fittings	Reference	Price from
1 BP	FC3008A-A1100010	92,35
Engraving 1 word	FZ9999Z-ZGR0001M99	+ 10,00

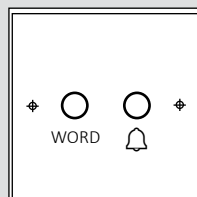

Fittings	Reference	Price from
2 BP	FC3008A-A1100021	114,42
Engraving 1 word	FZ9999Z-ZGR0001M99	+ 10,00
Engraving 1 symbol	FZ9999Z-ZGR1001S99	+ 10,00

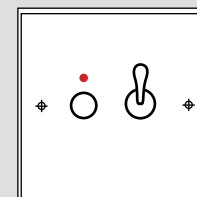

Fittings	Reference	Price from
1 BP + 1 V&V	FC3008A-A1100021	114,42
1 LED indicator	FZLED1Z-Z00D301299	+ 16,29



80x80x3

Balilage asymétrique 2700k-chaud  
Balilage asymétrique 4000k-froid

FC3008C-K1002260  
FC3008C-K1002261

205,56

215,83

246,67

296,00











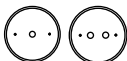



Prices 04/24 in euros  
without VAT

# CLASSIQUE

Diagrams	Back box colour	Size (mm)	Fittings	Reference	Cold finishes	Warm finishes	Special finishes	Shiny Gilding
	●	80x80x3	Blank	FC3008A-B0000000	70,28	73,80	84,34	101,21
	●	80x80x3	1 PC 2x10/16A+T	FC3008A-B0000010	94,80	99,54	113,76	136,51
			1 PC + Cover	FC3008A-F0000010	202,07	212,18	242,49	290,99
	●	80x80x3	1 universal PC Wonpro	FC3008A-W5000010	104,99	110,24	125,99	151,19
			1 universal PC Wonpro + Cover	FC3008A-F5000010	212,26	222,88	254,72	305,66
	●	80x80x3	1 DIN base	FC3008A-B0001621	89,14	93,60	106,96	128,35
			2 DIN bases	FC3008A-B0001631	108,00	113,40	129,60	155,52
	●	80x80x3	1 Speaker	FC3008A-B0001540	104,19	109,40	125,03	150,04
	●	80x80x3	2 Flush RCA sockets	FC3008A-B0001870	146,81	154,15	176,17	211,40
	●	80x80x3	1 TV outlet	FC3008A-B0001700	80,22	84,23	96,26	115,51
			2 TV outlets	FC3008A-B0001710	90,16	94,66	108,19	129,83
	●	80x80x3	1 TV-FM-SAT	FC3008A-B0000570	135,05	141,80	162,06	194,47
	●	80x80x3	1 HDMI	FC3008A-B0001460	112,49	118,11	134,98	161,98
			2 HDMI	FC3008A-B0001470	154,69	162,43	185,63	222,76
	●	80x80x3	1 RJ45	FC3008A-B0000730	108,62	114,05	130,34	156,41
			2 RJ45	FC3008A-B0000740	146,95	154,30	176,34	211,61
			1 A or C USB power	FC3008A-B0001211	170,73	179,26	204,87	245,84
	●	80x80x3	1 double AA or AC USB power	FC3008A-B0001221	177,56	186,44	213,08	255,70
			1 double CC USB power	FC3008A-B0001223	203,96	214,16	244,75	293,70
			1 A or C USB F/F adaptator	FC3008A-B0001220	111,17	116,72	133,40	160,08
			2 AA, CC ou AC USB F/F adaptators	FC3008A-B0001220	152,06	159,66	182,47	218,96
	●	80x80x3	1 Cable outlet	FC3008A-B0001290	77,17	81,03	92,60	111,12
			1 Cable lead-out	FC3008A-B0001370	169,80	178,29	203,76	244,51
			1 Brush cable lead-out	FC3008A-B0001292	100,94	105,99	121,13	145,36

















Prices 04/24 in euros  
without VAT

# CLASSIQUE

Diagrams	Back box colour	Size (mm)	Fittings	Reference	Cold finishes	Warm finishes	Special finishes	Shiny Gilding
		Ø98x3	1 control element	FC3009A-A1100010	123,56	129,74	148,27	177,92
			2 control elements	FC3009A-A1100021	145,64	152,92	174,77	209,72
		Ø98x3	Blank	FC3009A-B0000000	101,49	106,57	121,79	146,15
		Ø98x3	1 PC 2x10/16A+T	FC3009A-B0000010	126,01	132,31	151,21	181,45
		Ø98x3	1 DIN base	FC3009A-B0001621	120,35	126,37	144,41	173,29
			2 DIN bases	FC3009A-B0001631	139,21	146,17	167,06	200,47
		Ø98x3	1 Speaker	FC3009A-B0001540	135,40	142,17	162,48	194,98
		Ø98x3	2 Flush RCA sockets	FC3009A-B0001870	178,03	186,93	213,64	256,37
		Ø98x3	1 TV outlet	FC3009A-B0001700	111,43	117,00	133,71	160,45
			2 TV outlets	FC3009A-B0001710	121,37	127,44	145,64	174,77
		Ø98x3	1 TV-FM-SAT	FC3009A-B0000570	166,28	174,58	199,53	239,44
		Ø98x3	1 HDMI	FC3009A-B0001460	143,70	150,89	172,44	206,93
		Ø98x3	1 RJ45	FC3009A-B0000730	139,83	146,82	167,79	201,35
			2 RJ45	FC3009A-B0000740	178,16	187,08	213,79	256,55
		Ø98x3	1 A or C USB power	FC3009A-B0001211	201,94	212,04	242,32	290,78
1 double AA or AC USB power			FC3009A-B0001221	208,77	219,21	250,53	300,64	
1 double CC USB power			FC3009A-B0001223	235,17	246,93	282,21	338,65	
	Ø98x3	1 Cable outlet	FC3009A-B0001290	108,38	113,80	130,05	156,06	
		1 Cable lead-out	FC3009A-B0001370	201,02	211,07	241,23	289,48	

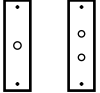
Prices 04/24 in euros  
without VAT

# CLASSIQUE







Diagrams	Back box colour	Size (mm)	Fittings	Reference	Cold finishes	Warm finishes	Special finishes	Shiny Gilding
		56x56x3	1 V&V or 1 BP *	FC3013A-A1100010	85,62	89,91	102,75	123,30
		∅56x3	1 V&V or 1 BP *	FC3014A-A1100010	99,43	104,41	119,32	143,18
		Hexagonal shape	1 control element	FC3015A-A1100010	119,96	125,96	143,96	172,75
		Octagonal shape	1 control element	FC3016A-A1100010	119,96	125,96	143,96	172,75
		Oval shape	1 control element	FC3017A-A1100010	119,96	125,96	143,96	172,75
		38x91x3	1 control element	FC3011A-A1100010	92,35	96,97	110,82	132,98
		38x133x3	1 control element 2 control elements	FC3010A-A1100010 FC3010A-A1100020	100,06 122,14	105,06 128,24	120,07 146,57	144,08 175,88
		38x175x3	3 control elements	FC3012A-A1100030	164,74	172,97	197,68	237,22

\*V&V : 600 series  
BP : 1200 series

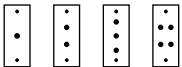
Prices 04/24 in euros  
without VAT

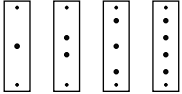

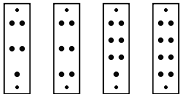

# CLASSIQUE

Diagrams	Back box colour	Size (mm)	Fittings	Reference	Cold finishes	Warm finishes	Special finishes	Shiny Gilding
		38x91x3	1 12V-mini BP chromé	FC3011A-K3000070	93,78	98,47	112,53	135,04
			2 12V-mini BP chromé	FC3011A-K3000080	117,27	123,14	140,72	168,86
			3 12V-mini BP chromé	FC3011A-K3000090	140,76	147,80	168,92	202,70
			4 12V-mini BP chromé	FC3011A-K3000100	164,26	172,47	197,11	236,53
		38x133x3	1 12V-mini BP chromé	FC3010A-K3000070	101,48	106,56	121,78	146,14
			2 12V-mini BP chromé	FC3010A-K3000080	124,98	131,23	149,97	179,96
			3 12V-mini BP chromé	FC3010A-K3000090	148,47	155,90	178,16	213,79
			4 12V-mini BP chromé	FC3010A-K3000100	171,96	180,56	206,36	247,63
		38x133x3	5 12V-mini BP chromé	FC3010A-K3000110	195,47	205,24	234,56	281,47
			6 12V-mini BP chromé	FC3010A-K3000120	218,96	229,91	262,76	315,31
			7 12V-mini BP chromé	FC3010A-K3000130	242,46	254,58	290,95	349,14
			8 12V-mini BP chromé	FC3010A-K3000140	265,95	279,25	319,13	382,96
	* See box	Ø8x4,5 mm	Flat caps	FZCAP0Z-K3000010	24,72	25,96	29,65	35,58
			Rounded cap	FZCAP0Z-K3000020				

\* For more aesthetics and comfort, flat or rounded caps can be placed on buttons.

Prices 04/24 in euros without VAT

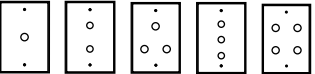
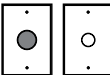
# CLASSIQUE

Diagrams	Back box colour	Size (mm)	Fittings	Reference	Cold finishes	Warm finishes	Special finishes	Shiny Gilding
	●	80x115x3	1 control element	FC3001A-A1100010	100,06	105,06	120,07	144,08
			2 control elements	FC3001A-A1100020	122,14	128,24	146,57	175,88
			3 control elements in triangle	FC3001A-A1100031	144,21	151,41	173,05	207,66
			3 BP or 3 BPE in line	FC3001A-A1100090	144,21	151,41	173,05	207,66
			4 control elements	FC3001A-A1100040	166,29	174,60	199,54	239,45
	●	80x115x3	1 Electronic Dimmer NU3514	FC3001A-K1000023	307,72	323,10	369,26	443,11
			1 Universal Dimmer S520519	FC3001A-K1000022	241,05	253,10	289,27	347,12
	●	80x115x3	1 Motion detector Leg. 67026	FC3001A-K1000135	344,76	362,00	413,71	496,45

Prices 04/24 in euros  
without VAT

## Control elements examples with options

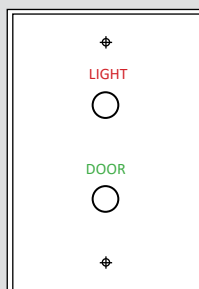



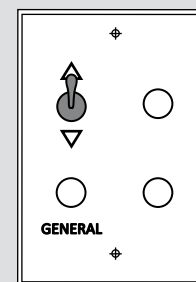



Fittings	Reference	Prices from
2 BP	FC3001A-A1100020	122,14
Light engraving	FZ9999Z-ZGLU000199	+60,00
Additional light engraving	FZ9999Z-ZGLU100199	+60,00

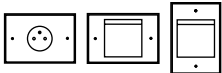

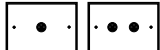
Fittings	Reference	Prices from
1 Inv auto + 3 BP	FC3001A-A1100040	166,29
Engraving 2 triangles	FZ9999Z-ZGR0002T99	+ 20,00
Engraving 1 word	FZ9999Z-ZGR1001M99	+ 10,00
Resin engraving 1 word	FZ9999Z-ZR00001M99	+ 16,00

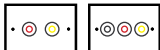
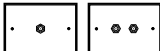

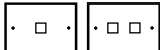
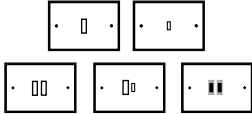
# CLASSIQUE

Diagrams	Back box colour	Size (mm)	Fittings	Reference	Cold finishes	Warm finishes	Special finishes	Shiny Gilding
	●	115x80x3	Blank	FC3000A-B0000000	77,99	81,89	93,59	112,31
	●	115x80x3	1 PC 2x10/16A+T	FC3000A-B0000010	102,51	107,64	123,01	147,61
	●	115x80x3	1 PC + Cover (horizontal)	FC3000A-F0000010	} 209,79	220,28	251,74	302,09
	●	80x115x3	1 PC + Cover (vertical)	FC3001A-F0000010				
	●	115x80x3	1 universal PC Wonpro	FC3000A-W5000010	112,70	118,34	135,24	162,29
	●	115x80x3	1 DIN base	FC3000A-B0001621	96,86	101,70	116,23	139,48
	●		2 DIN bases	FC3000A-B0001631	115,71	121,49	138,85	166,62
	●	115x80x3	1 Speaker	FC3000A-B0001540	111,90	117,50	134,28	161,14
	●	115x80x3	2 Flush RCA sockets	FC3000A-B0001870	154,52	162,25	185,43	222,52
	●		3 Flush RCA sockets	FC3000A-B0001880	192,78	202,43	231,34	277,61
	●	115x80x3	1 TV outlet	FC3000A-B0001700	87,93	92,33	105,52	126,62
	●		2 TV outlets	FC3000A-B0001710	97,86	102,76	117,44	140,93
	●	115x80x3	1 TV-FM-SAT	FC3000A-B0000570	142,77	149,91	171,33	205,60
	●	115x80x3	1 HDMI	FC3000A-B0001460	120,19	126,20	144,23	173,08
	●	115x80x3	1 RJ45	FC3000A-B0000730	116,32	122,14	139,59	167,51
	●		2 RJ45	FC3000A-B0000740	154,66	162,40	185,59	222,71
	●	115x80x3	1 A or C USB power	FC3000A-B0001211	178,43	187,36	214,12	256,94
			1 double AA or AC USB power	FC3000A-B0001221	185,28	194,54	222,33	266,80
			1 double CC USB power	FC3000A-B0001223	211,67	222,26	254,01	304,81
			1 A or C USB F/F adaptor	FC3000A-B0001210	178,43	187,36	214,12	256,94

Plinth size possible  
115x63x3  
Contact us

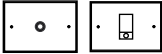

Prices 04/24 in euros  
without VAT

# CLASSIQUE

Special plates	Back box colour	Size (mm)	Fittings	Reference	Cold finishes	Warm finishes	Special finishes	Shiny Gilding
	●	115x80x3	1 Cable outlet	FC3000A-B0001290	84,87	89,12	101,85	122,22
			1 Cable lead-out	FC3000A-B0001370	177,52	186,39	213,02	255,62
	●	115x80x3	Vimar Shaver socket	FC3000A-B1001300	336,97	353,82	404,36	485,23
	●	80x115x3	HAGER key card switch	FC3001A-K1000180	405,29	425,56	486,35	583,62

Prices 04/24 in euros  
without VAT

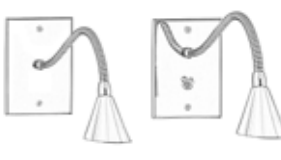
# CLASSIQUE

Tulipe reading lamps	Back box colour	Size (mm)	Fittings	Reference	Cold finishes	Warm finishes	Special finishes	Shiny Gilding
	●	80x115x3	bend 0°	FC3001A-M1000020	383,67	402,85	460,40	552,48
			bend 135°	FC3001A-M1000010				
	●	80x115x3	bend 0° + 1 control element	FC3001A-M1000080	405,74	426,03	486,89	584,27
			bend 135° + 1 control element	FC3001A-M1000070				
<div style="background-color: #cccccc; padding: 5px; text-align: center;">STRAIGHT CONE</div>								
	○	38x133x3	bend 0° + 1 control element	FC3010A-M1000080	405,74	426,03	486,89	584,27
			bend 135° + 1 control element	FC3010A-M1000070				
	●	80x115x3	bend 0° + 2 control elements	FC3001A-M1000380	427,81	449,21	513,38	616,06
			bend 135° + 2 control elements	FC3001A-M1000370				
	●	80x115x3	bend 0°	FC3001A-M1000050	383,67	402,85	460,40	552,48
			bend 135°	FC3001A-M1000040				
	●	80x115x3	bend 0° + 1 control element	FC3001A-M1000110	405,74	426,03	486,89	584,27
			bend 135° + 1 control element	FC3001A-M1000100				
<div style="background-color: #cccccc; padding: 5px; text-align: center;">BEVELED CONE</div>								
	○	38x133x3	bend 0° + 1 control element	FC3010A-M1000110	405,74	426,03	486,89	584,27
			bend 135° + 1 control element	FC3010A-M1000100				
	●	80x115x3	bend 0° + 2 control elements	FC3001A-M1000410	427,81	449,21	513,38	616,06
			bend 135° + 2 control elements	FC3001A-M1000400				

Please see technical details  
from page 66

Tulipe straight cone





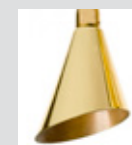



Tulipe beveled cone



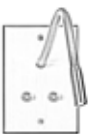



Prices 04/24 in euros  
without VAT

# CLASSIQUE

Roseau reading lamps		Back box colour	Size (mm)	Fittings	Reference	Cold finishes	Warm finishes	Special finishes	Shiny Gilding
		●	80x115x3	bend 0°	FC3001A-M2000020	325,51	341,79	390,61	468,73
				bend 135°	FC3001A-M2000010				
		●	80x115x3	bend 0° + 1 control element	FC3001A-M2000080	347,58	364,96	417,09	500,51
				bend 135° + 1 control element	FC3001A-M2000070				
		○	38x133x3	bend 0° + 1 control element	FC3010A-M2000080	347,58	364,96	417,09	500,51
				bend 135° + 1 control element	FC3010A-M2000070				
		●	80x115x3	bend 0° + 2 control elements	FC3001A-M2000380	369,66	388,14	443,59	532,31
				bend 135° + 2 control elements	FC3001A-M2000370				



## Tactile reading lamps

		●	80x115x3	bend 0° + 1 LED	FC3001A-M3000020	478,31	502,23	573,97	688,76
				bend 135° + 1 LED	FC3001A-M3000010				
		○	38x133x3	bend 0° + 1 LED	FC3010A-M3000020	478,31	502,23	573,97	688,76
				bend 135° + 1 LED	FC3010A-M3000010				

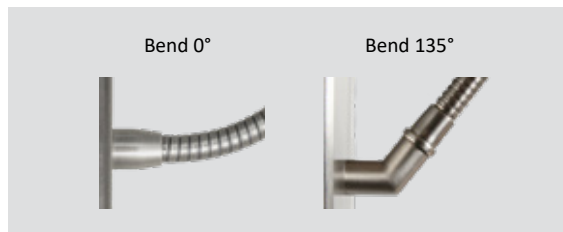





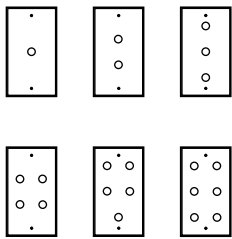
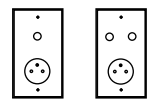
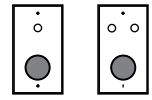
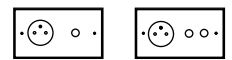
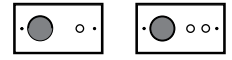

Prices 04/24 in euros without VAT

# CLASSIQUE

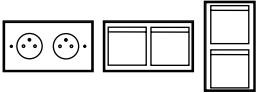
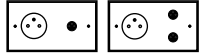
Diagrams	Back box colour	Size (mm)	Fittings	Reference	Cold finishes	Warm finishes	Special finishes	Shiny Gilding
	●	80x142x3	1 control element	FC3003A-A1100010	120,59	126,62	144,71	173,65
			2 control elements	FC3003A-A1100020	142,67	149,80	171,20	205,44
			3 control elements	FC3003A-A1100030	164,74	172,97	197,68	237,22
			4 control elements	FC3003A-A1100040	186,80	196,14	224,16	268,99
			5 control elements	FC3003A-A1100050	208,88	219,33	250,66	300,79
			6 control elements	FC3003A-A1100060	230,95	242,50	277,14	332,57
	●	80x142x3	1 PC + 1 control element	FC3003A-C0010010	145,11	152,37	174,14	208,97
			1 PC + 2 control elements	FC3003A-C0010020	167,18	175,54	200,62	240,74
	●	80x142x3	1 Var E + 1 control element	FC3003A-K1000313	350,31	367,83	420,38	504,46
			1 Var E + 2 control elements	FC3003A-K1000333	372,38	391,00	446,86	536,23
	●	142x80x3	1 PC + 1 control element	FC3002A-C0010010	145,11	152,37	174,14	208,97
			1 PC + 2 control elements	FC3002A-C0010020	167,18	175,54	200,62	240,74
	●	142x80x3	1 Var E + 1 control element	FC3002A-K1000313	350,31	367,83	420,38	504,46
			1 Var E + 2 control elements	FC3002A-K1000333	372,38	391,00	446,86	536,23

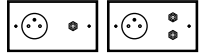
Prices 04/24 in euros  
without VAT

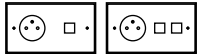
# CLASSIQUE

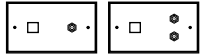
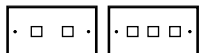
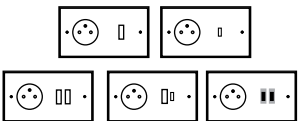

Diagrams	Back box colour	Size (mm)	Fittings	Reference	Cold finishes	Warm finishes	Special finishes	Shiny Gilding
	●	142x80x3	Blank	FC3002A-B0000000	98,52	103,45	118,23	141,88
	●	142x80x3	2 PC 2x10/16A+T	FC3002A-B0000020	147,56	154,93	177,07	212,48
	●	142x80x3	2 PC + Covers (horizontal)	FC3002A-F0000020	362,11	380,21	434,53	521,44
	●	80x142x3	2 PC + Covers (vertical)	FC3003A-F0000020				
	●	142x80x3	1 PC + 1 DIN base	FC3002A-B0052640	141,90	148,99	170,28	204,34
	●	142x80x3	1 PC + 2 DIN bases	FC3002A-B0052710	160,76	168,80	192,92	231,50
	●	142x80x3	1 PC + 1 Speaker	FC3002A-B0047320	156,95	164,80	188,33	226,00
	●	142x80x3	1 PC + 1 TV outlet	FC3002A-B0058240	132,97	139,62	159,57	191,48
	●	142x80x3	1 PC + 2 TV outlets	FC3002A-B0058310	142,91	150,05	171,49	205,79
	●	142x80x3	1 PC + 1 TV-FM-SAT	FC3002A-B0007340	187,81	197,20	225,38	270,46
	●	142x80x3	1 PC + 1 RJ45	FC3002A-B0010640	161,37	169,44	193,64	232,37
	●	142x80x3	1 PC + 2 RJ45	FC3002A-B0010710	199,70	209,68	239,64	287,57
	●	142x80x3	1 RJ45 + 1 TV-FM-SAT	FC3002A-B0012600	201,64	211,71	241,97	290,36
	●	142x80x3	1 RJ45 + 1 TV outlet	FC3002A-B0060760	146,79	154,13	176,14	211,37
	●	142x80x3	1 RJ45 + 2 TV outlets	FC3002A-B0060830	156,73	164,57	188,07	225,68
	●	142x80x3	2 RJ45	FC3002A-B0000740	175,19	183,94	210,23	252,28
	●	142x80x3	3 RJ45	FC3002A-B0000750	213,52	224,20	256,22	307,46
	●	142x80x3	1 PC + 1 A or C USB power	FC3002A-B0028841	223,48	234,64	268,17	321,80
	●	142x80x3	1 PC + 1 double AA or AC USB power	FC3002A-B0028911	230,32	241,83	276,38	331,66
	●	142x80x3	1 PC + 1 double CC USB power	FC3002A-B0028913	256,72	269,55	308,06	369,67

Plinth size possible  
142x63x3  
Contact us

Prices 04/24 in euros  
without VAT

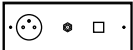

# CLASSIQUE

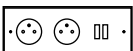
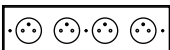
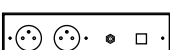
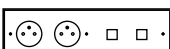
Diagrams	Back box colour	Size (mm)	Fittings	Reference	Cold finishes	Warm finishes	Special finishes	Shiny Gilding
	●	205x80x3	Blank	FC3004A-B0000000	160,76	168,80	192,92	231,50
	●	205x80x3	3 PC 2x10/16A+T	FC3004A-B0000030	234,32	246,04	281,18	337,42
	●	205x80x3	2 PC + 1 TV outlet	FC3004A-B0058250	219,73	230,71	263,68	316,42
	●	205x80x3	2 PC + 2 TV outlets	FC3004A-B0058320	229,67	241,16	275,61	330,73
	●	205x80x3	2 PC + 1 TV-FM-SAT	FC3004A-B0007350	274,58	288,31	329,49	395,39
	●	205x80x3	1 PC + 1 TV outlet + 1 RJ45	FC3004A-B1631560	233,55	245,23	280,26	336,31
	●	205x80x3	1 PC + 2 TV outlets + 1 RJ45	FC3004A-B1631770	243,48	255,66	292,18	350,62
	●	205x80x3	1 PC + 1 TV-FM-SAT + 1 RJ45	FC3004A-B1051950	288,39	302,82	346,07	415,28
	●	205x80x3	2 PC + 1 RJ45	FC3004A-B0010650	248,13	260,54	297,76	357,31
	●	205x80x3	2 PC + 2 RJ45	FC3004A-B0010720	286,47	300,79	343,76	412,51
	●	205x80x3	1 PC + 1 USB + 1 RJ45	FC3004A-B1074640	324,05	340,26	388,87	466,64
	●	205x80x3	2 PC + 1 Type A USB power	FC3004A-B0028851	310,24	325,76	372,29	446,75
	●	205x80x3	2 PC + 1 double AA or AC USB power	FC3004A-B0028921	317,08	332,92	380,49	456,59
	●	205x80x3	2 PC + 1 double CC USB power	FC3004A-B0028924	343,48	360,66	412,18	494,61
	●	267x80x3	Blank	FC3006A-B0000000	201,36	211,43	241,63	289,96
	●	267x80x3	4 PC 2x10/16A+T	FC3006A-B0000040	299,44	314,41	359,32	431,18
	●	267x80x3	3 PC + 1 TV outlet	FC3006A-B0058260	284,86	299,10	341,83	410,20
	●	267x80x3	3 PC + 2 TV outlets	FC3006A-B0058330	294,80	309,54	353,76	424,51
	●	267x80x3	3 PC + 1 TV-FM-SAT	FC3006A-B0007360	339,71	356,69	407,65	489,18
	●	267x80x3	2 PC + 1 TV outlet + 1 RJ45	FC3006A-B1631571	298,68	313,61	358,42	430,10
	●	267x80x3	2 PC + 2 TV outlets + 1 RJ45	FC3006A-B1631781	308,61	324,04	370,33	444,40
	●	267x80x3	2 PC + 2 RJ45	FC3006A-B0010720	327,07	343,42	392,49	470,99
	●	267x80x3	3 PC + 1 RJ45	FC3006A-B0010660	313,26	328,92	375,91	451,09
	●	267x80x3	3 PC + 2 RJ45	FC3006A-B0010730	351,59	369,17	421,91	506,29

Prices 04/24 in euros  
without VAT

# CLASSIQUE - EXPORT STANDARD SOCKETS

Diagrams	Back box colour	Size (mm)	Fittings	Reference	Cold finishes	Warm finishes	Special finishes	Shiny Gilding
	●	115x80x3	1 PC Schuko	FC3000A-B0000250	109,60	115,08	131,52	157,82
		115x80x3	1 PC Schuko + Cover (horizontal)	FC3000A-F0000250	} 216,87	227,72	260,25	312,30
		80x115x3	1 PC Schuko + Cover (vertical)	FC3001A-F0000250				
	●	115x80x3	1 PC Unel (Schuko + Bipasso)	FC3000A-B0000490	141,79	148,89	170,15	204,18
			1 PC Unel + 1 PC Bipasso	FC3000A-B0084980	186,46	195,78	223,76	268,51
	●	115x80x3	1 PC Bipasso	FC3000A-B0000410	122,67	128,80	147,20	176,64
			2 PC Bipasso	FC3000A-B0000420	167,34	175,71	200,80	240,96
			3 PC Bipasso	FC3000A-B0000430	212,01	222,61	254,42	305,30
	●	80x80x3	1 PC Schuko	FC3008A-B0000250	101,89	106,98	122,26	146,71
			1 PC Schuko + Cover	FC3008A-F0000250	209,16	219,63	250,99	301,19
	●	80x80x3	1 PC Unel (Schuko + Bipasso)	FC3008A-B0000490	134,08	140,78	160,89	193,07
	●	80x80x3	1 PC Bipasso	FC3008A-B0000410	114,95	120,70	137,95	165,54
			2 PC Bipasso	FC3008A-B0000420	159,63	167,61	191,56	229,87
	●	Ø98x3	1 PC Schuko	FC3009A-B0000250	133,10	139,76	159,72	191,66
	●	Ø98x3	1 PC Unel (Schuko + Bipasso)	FC3009A-B0000490	165,30	173,57	198,36	238,03
	●	Ø98x3	1 PC Bipasso	FC3009A-B0000410	146,16	153,47	175,40	210,48
			2 PC Bipasso	FC3009A-B0000420	190,84	200,39	229,01	274,81

Prices 04/24 in euros  
without VAT

# CLASSIQUE - EXPORT STANDARD SOCKETS

Diagrams	Back box colour	Size (mm)	Fittings	Reference	Cold finishes	Warm finishes	Special finishes	Shiny Gilding
	●	142x80x3	1 PC Schuko + 1 control element	FC3002A-C1610010	152,19	159,81	182,63	219,16
			1 PC Schuko + 2 control elements	FC3002A-C1610020	174,27	182,99	209,12	250,94
	●	80x142x3	1 control element + 1 PC Schuko	FC3003A-C1610010	152,19	159,81	182,63	219,16
			2 control elements + 1 PC Schuko	FC3003A-C1610020	174,27	182,99	209,12	250,94
	●	142x80x3	2 PC Schuko	FC3002A-B0000260	161,73	169,82	194,07	232,88
		142x80x3	2 PC Schuko + Covers (horizontal)	FC3002A-F0000260	376,28	395,10	451,54	541,85
		80x142x3	2 PC Schuko + Covers (vertical)	FC3003A-F0000260				
	●	142x80x3	1 PC Schuko + 1 DIN base	FC3002A-B0053480	148,98	156,43	178,78	214,54
			1 PC Schuko + 2 DIN bases	FC3002A-B0053550	167,85	176,24	201,42	241,70
	●	142x80x3	1 PC Schuko + 1 Speaker	FC3002A-B0048160	164,03	172,23	196,83	236,20
	●	142x80x3	1 PC Schuko + 1 TV outlet	FC3002A-B0059080	140,06	147,06	168,06	201,67
			1 PC Schuko + 2 TV outlets	FC3002A-B0059150	150,00	157,50	180,00	216,00
	●	142x80x3	1 PC Schuko + 1 TV-FM-SAT	FC3002A-B0008000	194,91	204,65	233,89	280,67
	●	142x80x3	1 PC Schuko + 1 RJ45	FC3002A-B0011480	168,46	176,88	202,16	242,59
			1 PC Schuko + 2 RJ45	FC3002A-B0011550	206,79	217,13	248,15	297,78
	●	142x80x3	1 PC Schuko + 1 A or C USB power	FC3002A-B0029681	230,57	242,10	276,68	332,02
			1 PC Schuko + 1 double AA or AC USB power	FC3002A-B0029751	237,40	249,27	284,88	341,86
	●	142x80x3	1 PC Schuko + 1 double CC USB power	FC3002A-B0029753	263,81	277,00	316,57	379,88
	●	142x80x3	1 PC Unel + 1 PC Bipasso	FC3002A-B0084980	206,99	217,34	248,39	298,07
			1 PC Unel + 2 PC Bipasso	FC3002A-B0085050	251,67	264,25	302,01	362,41

Prices 04/24 in euros  
without VAT

# CLASSIQUE - EXPORT STANDARD SOCKETS

Diagrams	Back box colour	Size (mm)	Fittings	Reference	Cold finishes	Warm finishes	Special finishes	Shiny Gilding
	●	205x80x3	3 PC Schuko	FC3004A-B0000270	255,58	268,36	306,70	368,04
	●	205x80x3	2 PC Schuko + 1 TV outlet	FC3004A-B0059090	233,91	245,61	280,69	336,83
	●		2 PC Schuko + 2 TV outlets	FC3004A-B0059160	243,85	256,04	292,61	351,13
	●	205x80x3	2 PC Schuko + 1 TV-FM-SAT	FC3004A-B0008010	288,76	303,19	346,51	415,81
	●	205x80x3	1 PC Schuko + 1 TV outlet + 1 RJ45	FC3004A-B1633240	240,64	252,67	288,77	346,52
	●		1 PC Schuko + 2 TV outlets + 1 RJ45	FC3004A-B1633450	250,58	263,11	300,70	360,84
	●	205x80x3	1 PC Schuko + 1 TV-FM-SAT + 1 RJ45	FC3004A-B1053510	295,48	310,26	354,58	425,50
	●	205x80x3	2 PC Schuko + 1 RJ45	FC3004A-B0011490	262,31	275,42	314,77	377,72
●	2 PC Schuko + 2 RJ45		FC3004A-B0011560	300,64	315,67	360,78	432,94	
	●	267x80x3	4 PC Schuko	FC3006A-B0000280	327,79	344,18	393,35	472,02
	●	267x80x3	3 PC Schuko + 1 TV outlet	FC3006A-B0059100	306,12	321,43	367,35	440,82
	●		3 PC Schuko + 2 TV outlets	FC3006A-B0059170	316,06	331,86	379,27	455,12
	●	267x80x3	3 PC Schuko + 1 TV-FM-SAT	FC3006A-B0008020	360,96	379,01	433,16	519,79
	●	267x80x3	2 PC Schuko + 1 TV outlet + 1 RJ45	FC3006A-B1633250	312,85	328,49	375,42	450,50
	●		2 PC Schuko + 2 TV outlets + 1 RJ45	FC3006A-B1633460	322,78	338,93	387,34	464,81
	●	267x80x3	2 PC Schuko + 2 RJ45	FC3006A-B0011560	341,24	358,31	409,49	491,39
	●		3 PC Schuko + 1 RJ45	FC3006A-B0011500	334,52	351,24	401,42	481,70
●	267x80x3	3 PC Schuko + 2 RJ45	FC3006A-B0011570	372,85	391,50	447,42	536,9	

Prices 04/24 in euros  
without VAT

# ELLIPSE COLLECTION

## SPECIFICATIONS

### General

- Switches, reading lamps and sockets
- Protection index: IP20 (*IP21 on request*)
- Products must be installed indoors and earthed
- Cleaning only with a soft and dry duster, no product

### Covering plate

- Solid brass 3mm thick
- With straight edges and visible screws
- **Screwless option available for some models – please contact us. Prices for backplates – p. 72**
- Finishes: Nickel, Chrome, Bronze médaille, Cuivre, Doré, Canon de fusil... (p.59)

### Control mechanisms

- Elongated base - Ellipse, Seattle or JMA lever (with additional charge) and lighting option or oblong push button
- Chrome-plated on cold and special finishes, golden on warm finishes
- Automatic connection by default, screw connection on request

## SIZES & BACK BOXES

Sizes (in mm)	Recommended back boxes
∅98 - 80x80 - 115x80 - 142x80	Mixed MELJAC, for dry partition and masonry
38x133	Narrow MELJAC, for masonry only

Can be adapted for other retail boxes: please contact us

### How to fix?



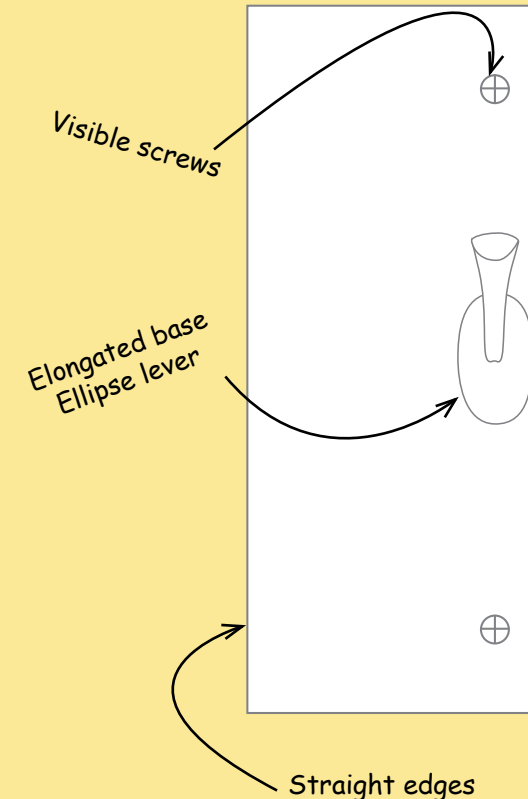
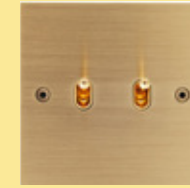



The covering plate is directly screwed onto the back box.



ORIGINE  
FRANCE®  
GARANTIE

BVCert. 6012053

# ELLIPSE

Diagrams	Back box colour	Size (mm)	Fittings	Reference	Cold finishes	Warm finishes	Special finishes	Shiny Gilding
 		80x80x3	1 control element	FE3008B-A1100010	132,23	138,84	158,67	190,40
			2 control elements	FE3008B-A1100021	194,17	203,88	233,00	279,60
 		Ø98x3	1 control element	FE3009B-A1100010	163,44	171,61	196,12	235,34
			2 control elements	FE3009B-A1100021	225,38	236,65	270,45	324,54

## Control elements





V&V

Inv auto

BP

Prices for Ellipse and Seattle toggles only





JMA lever: 27,04 € additional charge

3 toggle designs	
Ellipse lever	
Seattle lever	
JMA lever	

	Additional charges				
	Fittings		Bespoke options		
	Gold or chrome standard version	Chromé vif or gilding	Other color chart finishes	Polished mirror effect	Backlit
Ellipse lever	✓		✓ 16,64	or ✓ + 37,44	+ + 20,58
Seattle lever	✓		✓ 16,64	or + 37,44	+ + 20,58
JMA lever			✓ + 27,04		

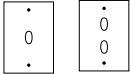

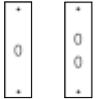
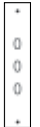

Prices 04/24 in euros without VAT

# ELLIPSE

Diagrams	Back box colour	Size (mm)	Fittings	Reference	Cold finishes	Warm finishes	Special finishes	Shiny Gilding
	●	80x115x3	1 control element	FE3001B-A1100010	139,93	146,93	167,92	201,50
			2 control elements	FE3001B-A1100020	201,87	211,97	242,25	290,70
	●	80x115x3	3 control elements in triangle	FE3001B-A1100031	263,82	277,00	316,58	379,90
	●	80x115x3	4 control elements	FE3001B-A1100040	325,76	342,05	390,92	469,10
	●	38x91x3	1 control element	FE3011B-A1100010	132,23	138,84	158,67	190,40
	○	38x133x3	1 control element	FE3010B-A1100010	139,93	146,93	167,92	201,50
			2 control elements	FE3010B-A1100020	201,87	211,97	242,25	290,70
	●	38x175x3	3 control elements	FE3012B-A1100030	284,35	298,56	341,21	409,45

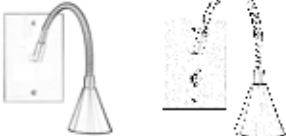
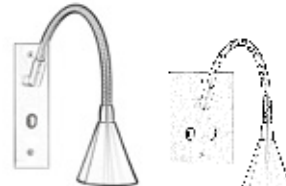
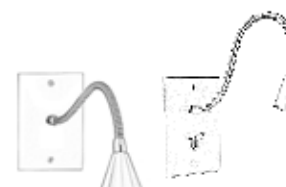
Prices 04/24 in euros  
without VAT

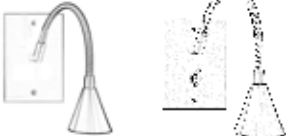
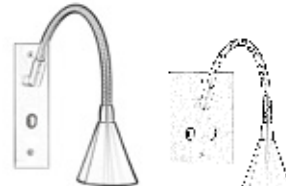
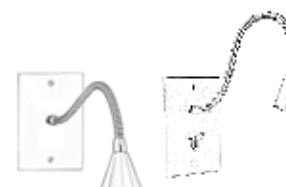
# ELLIPSE

Tulipe reading lamps		Back box colour	Size (mm)	Fittings	Reference	Cold finishes	Warm finishes	Special finishes	Shiny Gilding
	●	80x115x3	bend 0°	FE3001B-M1000020	383,67	402,85	460,40	552,48	
			bend 135°	FE3001B-M1000010					
	●	80x115x3	bend 0° + 1 control element	FE3001B-M1000080	445,61	467,89	534,73	641,68	
			bend 135° + 1 control element	FE3001B-M1000070					
	○	38x133x3	bend 0° + 1 control element	FE3010B-M1000080	445,61	467,89	534,73	641,68	
			bend 135° + 1 control element	FE3010B-M1000070					
	●	80x115x3	bend 0° + 2 control elements	FE3001B-M1000380	507,55	532,93	609,07	730,88	
			bend 135° + 2 control elements	FE3001B-M1000370					
	●	80x115x3	bend 0°	FE3001B-M1000050	383,67	402,85	460,40	552,48	
			bend 135°	FE3001B-M1000040					
	●	80x115x3	bend 0° + 1 control element	FE3001B-M1000110	445,61	467,89	534,73	641,68	
			bend 135° + 1 control element	FE3001B-M1000100					
	○	38x133x3	bend 0° + 1 control element	FE3010B-M1000110	445,61	467,89	534,73	641,68	
			bend 135° + 1 control element	FE3010B-M1000100					
	●	80x115x3	bend 0° + 2 control elements	FE3001B-M1000410	507,55	532,93	609,07	730,88	
			bend 135° + 2 control elements	FE3001B-M1000400					

STRAIGHT CONE

BEVELED CONE









Please see technical details from page 66



Prices 04/24 in euros without VAT



# ELLIPSE

Roseau reading lamps	Back box colour	Size (mm)	Fittings	Reference	Cold finishes	Warm finishes	Special finishes	Shiny Gilding
 	●	80x115x3	bend 0°	FE3001B-M2000020	325,51	341,79	390,61	468,73
			bend 135°	FE3001B-M2000010				
 	●	80x115x3	bend 0° + 1 control element	FE3001B-M2000080	387,45	406,83	464,94	557,93
			bend 135° + 1 control element	FE3001B-M2000070				
 	○	38x133x3	bend 0° + 1 control element	FE3010B-M2000080	387,45	406,83	464,94	557,93
			bend 135° + 1 control element	FE3010B-M2000070				
 	●	80x115x3	bend 0° + 2 control elements	FE3001B-M2000380	449,39	471,87	539,27	647,12
			bend 135° + 2 control elements	FE3001B-M2000370				

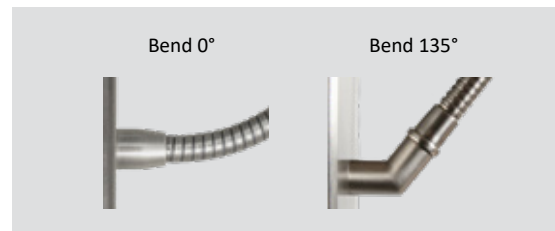





Prices 04/24 in euros  
without VAT

# ELLIPSE

Diagrams	Back box colour	Size (mm)	Fittings	Reference	Cold finishes	Warm finishes	Special finishes	Shiny Gilding
		80x142x3	3 control elements	FE3003B-A1100030	284,35	298,56	341,21	409,45
		80x142x3	4 control elements	FE3003B-A1100040	346,29	363,60	415,54	498,65
		80x142x3	5 control elements	FE3003B-A1100050	408,23	428,65	489,88	587,86
		80x142x3	6 control elements	FE3003B-A1100060	470,17	493,68	564,21	677,05
		80x142x3	1 control element + 1 PC	FE3003B-C0010010	184,97	194,22	221,97	266,36
		80x142x3	2 control elements + 1 PC	FE3003B-C0010020	246,93	259,27	296,32	355,58
		80x142x3	1 control element + Var E	FE3003B-K1000313	390,18	409,69	468,21	561,85
		80x142x3	2 control elements + 1 Var E	FE3003B-K1000333	452,12	474,73	542,55	651,06
		142x80x3	1 PC + 1 control element	FE3002B-C0010010	184,97	194,22	221,97	266,36
		142x80x3	1 PC + 2 control elements	FE3002B-C0010020	246,93	259,27	296,32	355,58
		142x80x3	1 Var E + 1 control element	FE3002B-K1000313	390,18	409,69	468,21	561,85
		142x80x3	1 Var E + 2 control elements	FE3002B-K1000333	452,12	474,73	542,55	651,06

Prices 04/24 in euros  
without VAT

# ELLIPSE - EXPORT STANDARD SOCKETS

Diagrams	Back box colour	Size (mm)	Fittings	Reference	Cold finishes	Warm finishes	Special finishes	Shiny Gilding
	●	142x80x3	1 PC Schuko + 1 control element	FE3002B-C1610010	192,07	201,67	230,48	276,58
	●	142x80x3	1 PC Schuko + 2 control elements	FE3002B-C1610020	254,01	266,71	304,81	365,77
	●	80x142x3	1 control element + 1 PC Schuko	FE3003B-C1610010	192,07	201,67	230,48	276,58
	●	80x142x3	2 control elements + 1 PC Schuko	FE3003B-C1610020	254,01	266,71	304,81	365,77

Prices 04/24 in euros  
without VAT

# DAMIER COLLECTION

## SPECIFICATIONS

### General

- Collection designed for low voltage 12V currents (home automation) and adaptable to high voltage 230V upon request
- Protection index: IP20 (IP21 on request)
- Products must be installed indoors and earthed
- Cleaning only with a soft and dry duster, no product

### Covering plate

- Solid brass 3mm thick
- With straight edges and non-visible screws (possible with visible screws: contact us)
- Finishes: Nickel, Chrome, Bronze médaille, Cuivre, Doré, Canon de fusil... (p.59)

### Control mechanisms

- Square push button 14x14mm in relief or flush
- Other button shapes possible (round, oval, triangular, rectangular...)
- In the same finish as the covering plate
- Screw connection

## SIZES & BACK BOXES

Sizes (in mm)	Back box
80x80 - 115x80 - 142x80	Mixed MELJAC, for dry partition and masonry

### How to fix?

The mounting plate with mechanisms screws directly onto the back box.  
The covering plate snaps onto the mounting plate.



BVCert. 6012053

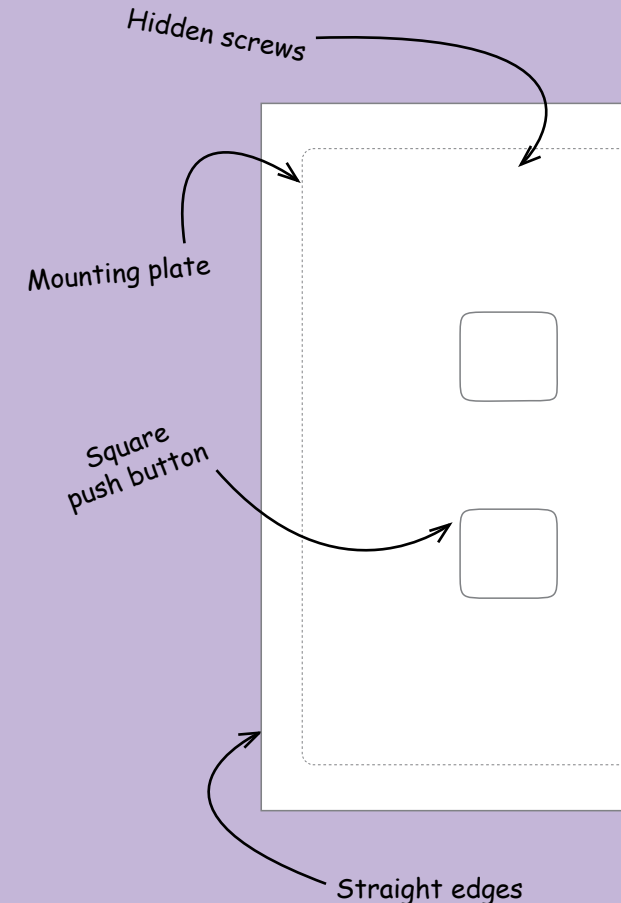

# DAMIER

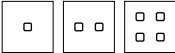
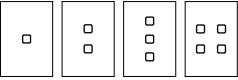
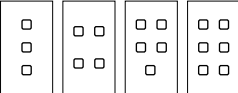
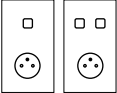
Diagrams	Back box colour	Size (mm)	Fittings	Reference	Cold finishes	Warm finishes	Special finishes	Shiny Gilding
	●	80x80x3	1 BP	FK3008D-K2000130	164,23	172,44	197,07	236,48
			2 BP	FK3008D-K2000140	195,77	205,56	234,93	281,92
			4 BP	FK3008D-K2000160	252,63	265,26	303,15	363,78
	●	80x115x3	1 BP	FK3001D-K2000130	171,93	180,53	206,32	247,58
			2 BP	FK3001D-K2000140	203,48	213,65	244,17	293,00
			3 BP	FK3001D-K2000150	232,96	244,61	279,55	335,46
			4 BP	FK3001D-K2000160	260,34	273,36	312,42	374,90
	●	80x142x3	3 BP	FK3003D-K2000150	259,72	272,71	311,66	373,99
			4 BP	FK3003D-K2000160	287,10	301,45	344,52	413,42
			5 BP	FK3003D-K2000170	326,20	342,50	391,44	469,73
			6 BP	FK3003D-K2000180	365,28	383,54	438,34	526,01
	●	80x142x3	1 BP + 1 PC	FK3003D-K2500130	223,23	234,39	267,88	321,46
			2 BP + 1 PC	FK3003D-K2500140	254,77	267,51	305,72	366,86

To specify :  
 - BP in 12V or 230V  
 - BP in relief or flush

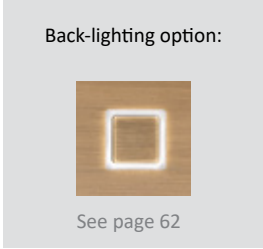
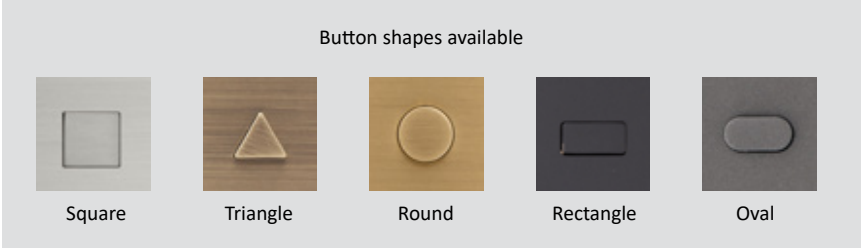

Prices 04/24 in euros without VAT

# CANNELÉE COLLECTION

Designed by Jean-Michel WILMOTTE

## SPECIFICATIONS

### General

- Switches, reading lamp and sockets (variation only with push buttons or automatic switches)
- Protection index: IP20
- Products must be installed indoors and earthed
- Cleaning only with a soft and dry duster, no product

### Covering plate

- Solid brass 5,5mm thick
- With straight edges and non-visible screws
- Different finishes are available on this mount (see page 59)

### Control mechanisms

- Elongated base - Ellipse, Seattle or JMA lever or oblong push button
- Chrome-plated on cold and special finishes, golden on warm finishes
- Automatic connection by default, screw connection on request

## SIZES & BACK BOXES

Sizes (in mm)	Recommended back boxes
80x80 - 151x80	Type LEGRAND 80051 / LEGRAND 80052

### How to fix?



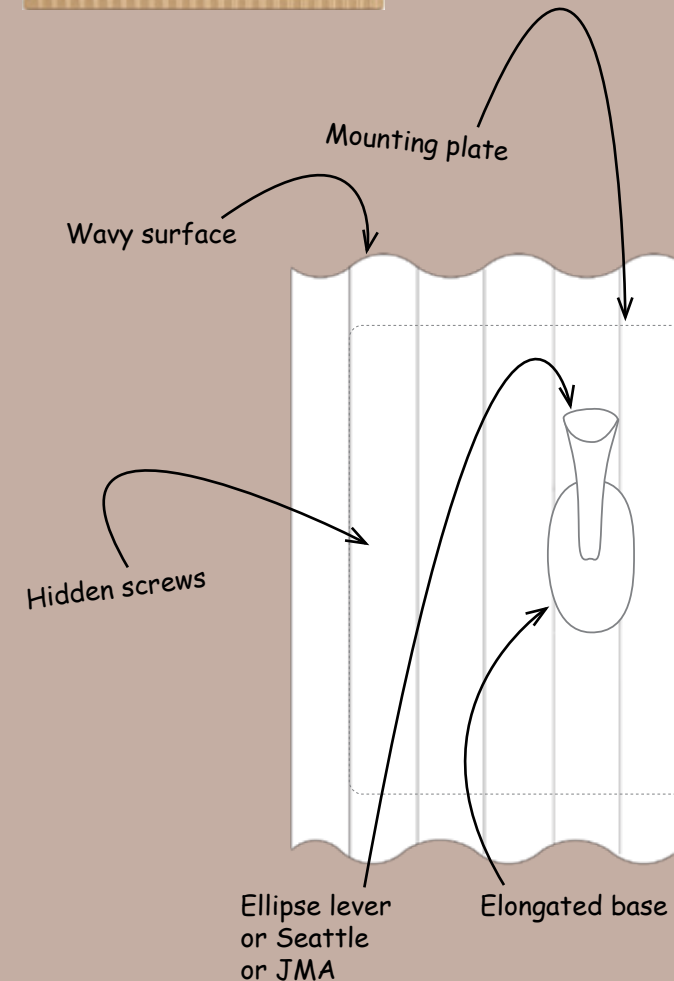







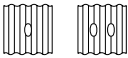













The mounting plate with mechanisms screws directly onto the back box.  
The covering plate is magnetized onto the mounting plate.

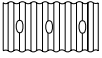

ORIGINE  
FRANCE®  
GARANTIE

BVCert. 6012053

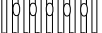
# CANNELÉE

Diagrams	Back box colour	Size (mm)	Fittings	Reference	**Cold finishes	**Warm finishes	**Special finishes	Shiny Gilding
		80x80x5,5	1 control element	FW5017K-A1100010	179,16	188,12	214,99	257,99
		80x80x5,5	2 control elements	FW5017K-A1100021	270,48	284,00	324,58	389,50
		80x80x5,5	1 PC 2x10/16A+T	FW5017K-B0000010	123,23	129,39	147,88	177,46
		80x80x5,5	1 RJ45	FW5017K-B0000730	142,82	149,97	171,39	205,67
		80x80x5,5	1 USB socket	FW5017K-B0001211	198,74	208,69	238,49	286,19
		80x80x5,5	1 cable outlet	FW5017K-B0001290	122,95	129,10	147,53	177,04
		80x80x5,5	1 TV outlet	FW5017K-B0001700	123,41	129,57	148,09	177,71
		80x80x5,5	Tactile reading lamp - bend 0°	FW5017K-M3000020	487,21	511,57	584,65	701,58
		80x80x5,5	Tactile reading lamp - bend 135°	FW5017K-M3000010				
		80x80x5,5	1 Thermostat Schneider S520509	FW5017K-K1000127	510,65	536,18	612,78	735,34
		151x80x5,5	3 control elements	FW5022K-A1100032	417,79	438,68	501,34	601,61
		151x80x5,5	4 control elements	FW5022K-A1100042	509,11	534,57	610,94	733,13
		151x80x5,5	5 control elements	FW5022K-A1100052	600,43	630,46	720,52	864,62

\*\*Available finishes =  page 59

Control elements:



V&V

Inv auto

BP

3 lever designs



Ellipse lever



Seattle lever



JMA lever











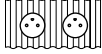



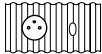

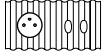



options: see page 20

Prices for Ellipse and Seattle toggles only

JMA lever:  
27,04 € additional charge

Prices 04/24 in euros  
without VAT

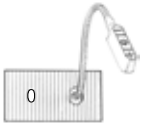
# CANNELÉE

Diagrams	Back box colour	Size (mm)	Fittings	Reference	**Cold finishes	**Warm finishes	**Special finishes	Shiny Gilding
		151x80x5,5	2 PC 2x10/16A+T	FW5022K-B0000020	214,61	225,35	257,54	309,05
		151x80x5,5	2 RJ45 3 RJ45	FW5022K-B0000740 FW5022K-B0000750	253,81 308,81	266,50 324,25	304,57 370,57	365,48 444,68
		151x80x5,5	1 PC + 1 control element	FW5022K-C0010010	270,55	284,08	324,66	389,59
		151x80x5,5	1 PC + 2 control elements	FW5022K-C0010020	361,87	379,96	434,24	521,09
		151x80x5,5	1 PC + 1 RJ45	FW5022K-B0010640	234,22	245,93	281,06	337,27
			1 PC + 2 RJ45	FW5022K-B0010710	289,21	303,67	347,05	416,46
		151x80x5,5	1 PC + 1 USB socket	FW5022K-B0028840	290,13	304,64	348,15	417,78
		151x80x5,5	1 PC + 1 TV outlet	FW5022K-B0058240	214,79	225,53	257,75	309,30
			1 PC + 2 TV outlets	FW5022K-B0058310	250,37	262,89	300,45	360,54
		151x80x5,5	1 control element + 1 tactile reading lamp- bend 0°	FW5022K-M3000140	634,52	666,26	761,43	913,72
			1 control element + 1 tactile reading lamp- bend 135°	FW5022K-M3000130				

\*\*Available finishes =  page 59

Silkscreen printing option,  
contact us

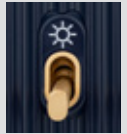

See page 62

Prices 04/24 in euros  
without VAT



# SOLARIS COLLECTION

Designed by Marc NEWSON

## SPECIFICATIONS

### General

- Designed for low voltage (smart homes), can be adapted for line voltage
- Switches and sockets (variation only with push buttons or automatic switches)
- Protection index: IP20
- Products must be installed indoors and earthed
- Cleaning only with a soft and dry duster, no product

### Covering plate

- Solid brass 3mm thick
- With straight edges, rounded corners and non-visible screws
- Different finishes are possible (see page 59)

### Control mechanisms

- Round base - Flattened toggle or flush concave push button
- Toggle in the same colour as the plate, shiny black base ring, black push button
- Automatic connection by default for automatic reversers (screw connection on request)
- Screw connection for push buttons

## SIZES & BACK BOXES

Sizes (in mm)	Back boxes
84x84 - 84x120 - 84x144 - 210x84	Mixed MELJAC, for dry partition and masonry

### How to fix?

The mounting plate with mechanisms screws directly onto the back box.  
The covering plate is clipped onto the mounting plate.

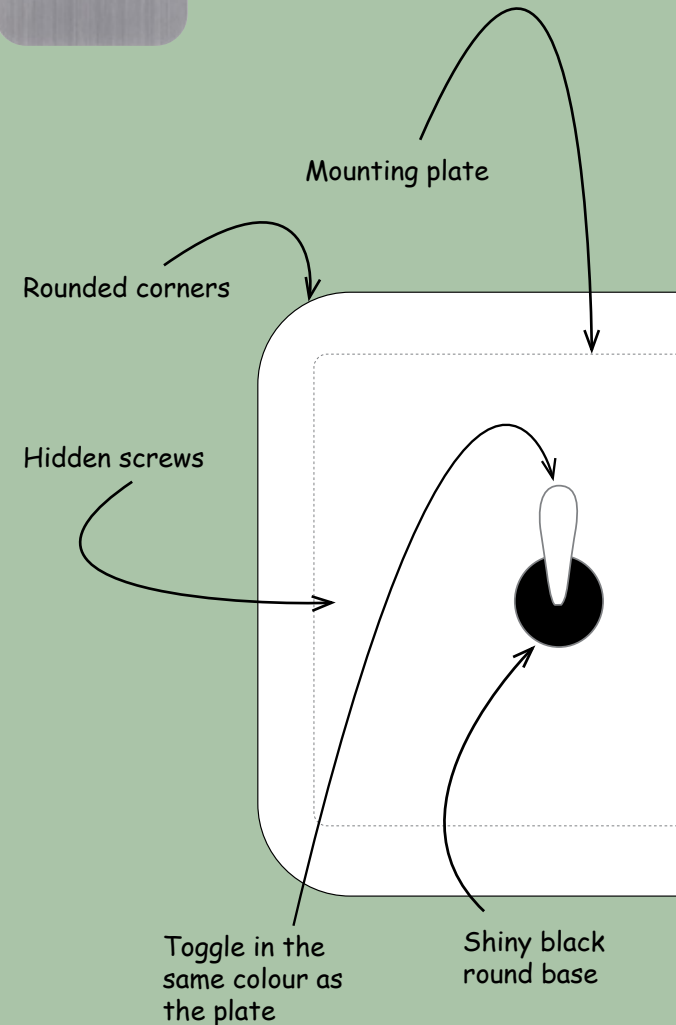

BVCert. 6012053

# SOLARIS





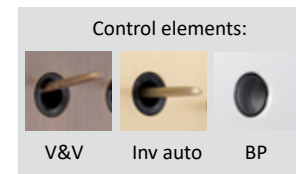







Diagrams	Back box colour	Size (mm)	Fittings	Reference	**Cold finishes	**Warm finishes	**Special finishes	Shiny Gilding
		84x84x3	1 BP 2 BP	FJ3208M-K2500070 FJ3208M-K2500080	187,69 220,81	197,07 231,86	225,22 264,97	270,26 317,96
		84x84x3	1 lever 2 levers	FJ3208M-A1100010 FJ3208M-A1100020	208,69 301,03	219,12 316,08	250,42 361,23	300,50 433,48
		84x84x3	1 lever + 1 BP	FJ3208M-K2500130	280,03	294,03	336,03	403,24
		84x84x3	1 Thermostat Schneider S520509	FJ3208M-K1000127	505,41	530,68	606,49	727,79
		84x120x3	1 BP 2 BP 4 BP	FJ3201M-K2500070 FJ3201M-K2500080 FJ3201M-K2500100	200,73 233,85 277,14	210,77 245,54 290,99	240,87 280,62 332,57	289,04 336,74 399,08
		84x120x3	1 lever 2 levers 4 levers	FJ3201M-A1100010 FJ3201M-A1100020 FJ3201M-A1100040	221,73 314,07 498,75	232,81 329,77 523,69	266,07 376,89 598,50	319,28 452,27 718,20
		84x120x3	1 lever + 1 BP 3 BP + 1 lever	FJ3201M-K2500130 FJ3201M-K2500170	293,07 343,61	307,73 360,79	351,69 412,33	422,03 494,80
		84x120x3	2 BP + 2 levers 1 BP + 3 levers	FJ3201M-K2500140 FJ3201M-K2500160	418,54 477,76	439,46 501,64	502,25 573,31	602,70 687,97
		120x84x3	1 BP 2 BP 4 BP	FJ3200M-K2500070 FJ3200M-K2500080 FJ3200M-K2500100	198,76 231,88 275,17	208,71 243,47 288,93	238,51 278,25 330,21	286,21 333,90 396,25
		120x84x3	1 lever 2 levers	FJ3200M-A1100010 FJ3200M-A1100020	219,76 312,10	230,76 327,71	263,71 374,52	316,45 449,42
		120x84x3	1 BP + 1 lever	FJ3200M-K2500130	291,10	305,66	349,32	419,18

\*\*Available finishes = page 59



Prices 04/24 in euros  
without VAT

# SOLARIS

Diagrams	Back box colour	Size (mm)	Fittings	Reference	**Cold finishes	**Warm finishes	**Special finishes	Shiny Gilding
			2 BP	FJ3203M-K2500020	258,23	271,15	309,88	371,86
		84x144x3	3 BP	FJ3203M-K2500030	275,64	289,42	330,77	396,92
			4 BP	FJ3203M-K2500040	301,52	316,60	361,82	434,18
			6 BP	FJ3203M-K2500120	375,39	394,16	450,47	540,56
								
			2 levers	FJ3203M-A1100020	338,45	355,37	406,14	487,37
		84x144x3	3 levers	FJ3203M-A1100030	430,79	452,33	516,94	620,33
			4 levers	FJ3203M-A1100040	523,13	549,29	627,75	753,30
			6 levers	FJ3203M-A1100060	707,81	743,20	849,38	1019,26
		84x144x3	3 levers + 3 BP	FJ3203M-K2500150	552,66	580,29	663,19	795,83
			2 BP	FJ3202M-K2500020	258,23	271,15	309,88	371,86
		144x84x3	3 BP	FJ3202M-K2500030	275,64	289,42	330,77	396,92
			6 BP	FJ3202M-K2500120	375,39	394,16	450,47	540,56
								
		144x84x3	2 levers	FJ3202M-A1100020	338,45	355,37	406,14	487,37
			3 levers	FJ3202M-A1100030	430,79	452,33	516,94	620,33

\*\*Available finishes =  page 59

Prices 04/24 in euros  
without VAT

# SOLARIS

Diagrams	Back box colour	Size (mm)	Fittings	Reference	**Cold finishes	**Warm finishes	**Special finishes	Shiny Gilding
		84x84x3	1 PC	FJ3208M-B0000010	140,87	147,91	169,04	202,85
		84x84x3	1 RJ45	FJ3208M-B0000730	178,46	187,39	214,16	256,99
	2 RJ45		FJ3208M-B0000740	240,58	252,62	288,70	346,44	
		84x84x3	1 A or C USB socket	FJ3208M-B0001211	216,80	227,64	260,16	312,19
	1 AA or AC double USB socket		FJ3208M-B0001221	223,63	234,81	268,36	322,03	
	1 CC double USB socket		FJ3208M-B0001223	250,03	262,53	300,04	360,04	
		144x84x3	1 PC + 1 control element	FJ3202M-C0010010	270,63	284,16	324,75	389,70
		144x84x3	2 PC	FJ3202M-B0000020	202,80	212,94	243,36	292,03
		144x84x3	1 PC + 1 RJ45	FJ3202M-B0010640	216,62	227,45	259,95	311,94
		144x84x3	1 PC + 1 A or C USB socket	FJ3202M-B0028841	278,73	292,67	334,47	401,36
	1 PC + 1 AA or AC double USB socket		FJ3202M-B0028911	285,56	299,84	342,68	411,22	
	1 PC + 1 CC double USB socket		FJ3202M-B0028913	311,97	327,56	374,36	449,23	
		210x84x3	3 PC	FJ3204M-B0000030	294,84	309,59	353,81	424,57
		210x84x3	2 PC + 1 AA, CC or AC double USB socket	FJ3204M-B0028921	377,60	396,48	453,13	543,76
		210x84x3	1 PC + 1 AA, CC or AC double USB socket + 1 RJ45	FJ3204M-B1214291	391,41	410,99	469,70	563,64

\*\*Available finishes = page 59

Prices 04/24 in euros  
without VAT

# TOURNAIRE COLLECTION

## SPECIFICATIONS

### General

- Switches
- Products must be installed indoors and earthed
- Cleaning only with a soft and dry duster, no product

### Covering plate

- 6mm-thick cast bronze (brass)
- With straight edges and non-visible screws
- 5 models replicating the six iconic motifs of the jewellery designer TOURNAIRE
- Three of the jewellery designer's 5 iconic motifs can be inlaid with precious stones: Alchimie, Bas-relief and Engrenages.
- Example of finishes: Argent Patiné (G5), Nickel Vieilli, Nickel Noir Brillant, Dorure (1N), Bronze Moyen dépoli, Dorure (3N) Vieillie...

### Control mechanisms

- Elongated base - Straight lever or Seattle lever with lighting option or push button
- Automatic connection by default, screw connection on request

## SIZES & BACK BOXES



Sizes (in mm)	Recommended back boxes
85x115	Mixed MELJAC, for dry partition and masonry

### How to fix?

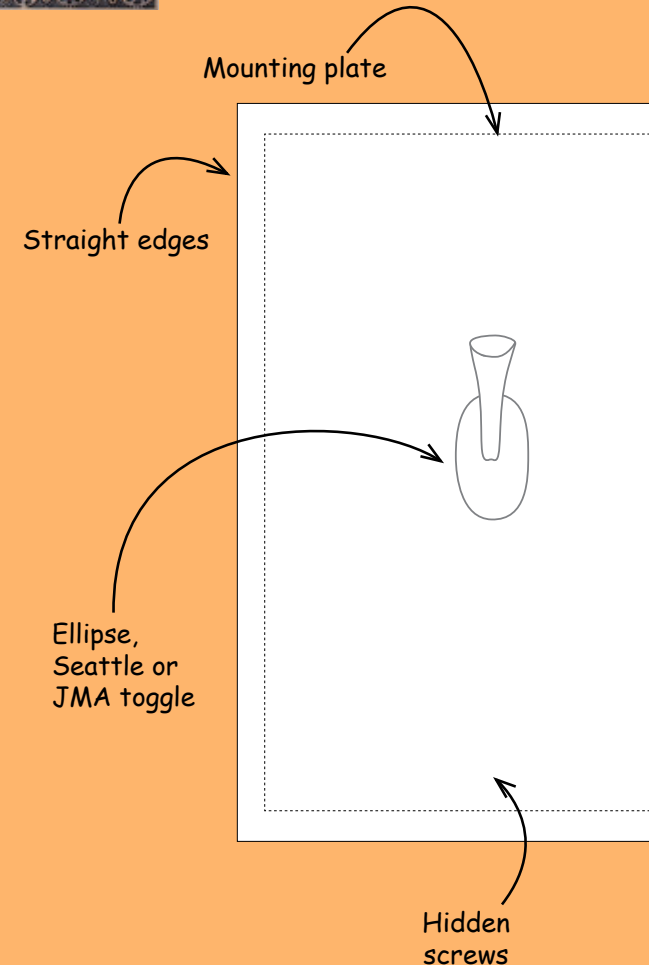
The mounting plate with mechanisms screws directly onto the back box.  
The covering plate snaps onto the mounting plate.



# TOURNAIRE COLLECTION

Diagrams	Back box colour	Size (mm)	Fittings	Reference	Special finishes
	●	85x115x6	1 control element	FA6003D-A1100010	853,00
	●	85x115x6	2 control elements	FA6003D-A1100020	971,09
	●	85x115x6	4 control elements	FA6003D-A1100040	1 207,32

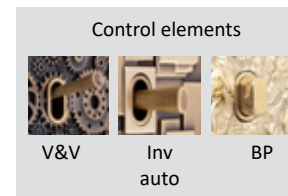

Prices 04/24 in euros  
without VAT

## Pattern (to be specified when ordering)



Alchimie\*

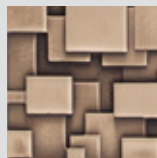

Construction



Engrenages\*



Bas-relief\*

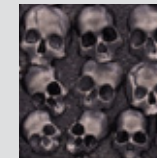

Catacombes

\*Models that can be set with precious stones.

# STUDIO COLLECTION

## SPECIFICATIONS

### General

- Switches
- Products must be installed indoors and earthed (*except for low current*)
- Cleaning only with a soft and dry duster, no product

### Plaque de recouvrement

- Solid brass 3mm thick
- \*Straight edges or chamfered (depending on the finish) screwless
- 7 finishes

### Control mechanisms

- Round base - Droplet lever or push button
- Automatic connection by default, screw connection on request

## SIZES & BACK BOXES



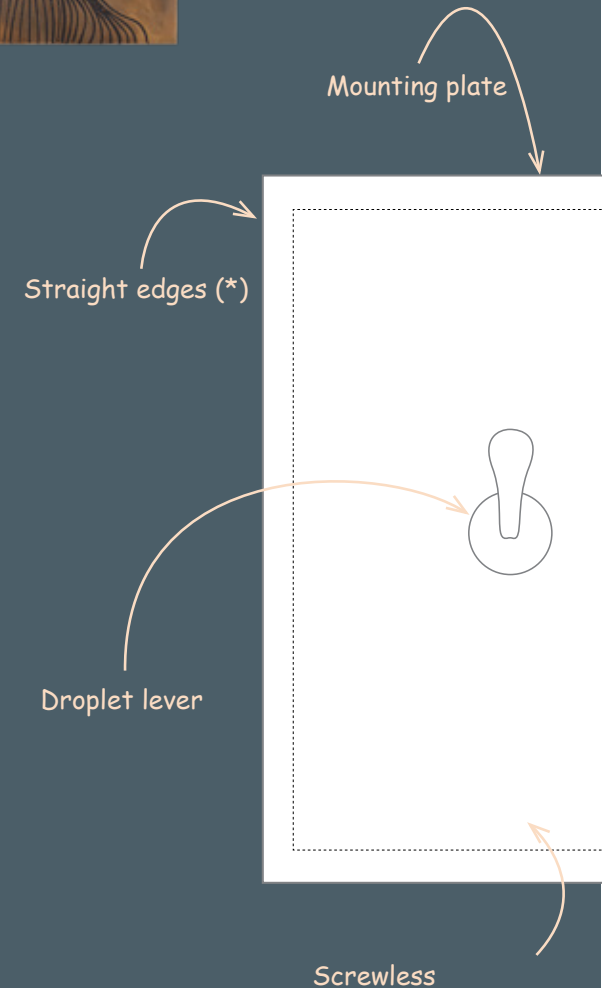
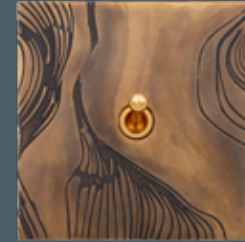

Sizes (in mm)	Recommended back boxes
80x80 - 115x80	Mixed MELJAC, for dry partition and masonry

### How to fix?

The covering plate is directly screwed onto the back box.



# STUDIO COLLECTION

Diagrams	Back box colour	Size (mm)	Fittings	Reference	Special finishes
		80x80x3	Méandres	FT3008D-A1100010AB	426,41
			Forest Automne } Forest Printemps }	FT3008D-A1100010AD	394,69
			Lagon	FT3008D-A1100010AG	261,71
			Plumes	FT3008D-A1100010AE	265,09
			Tissage	FT3008D-A1100021AF	313,69
			Noir Martelé	FT3008D-A1100010AC	273,19
					80x115x3
Forest Automne } Forest Printemps }	FT3001D-A1100010AD	447,86			
Lagon	FT3001D-A1100010AG	300,71			
Plumes	FT3001D-A1100010AE	303,41			
Tissage	FT3001D-A1100010AF	362,81			
Noir Martelé	FT3001D-A1100010AC	313,53			

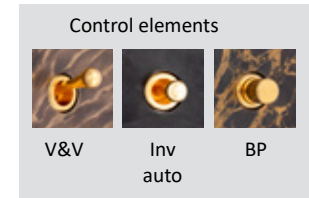

Prices 04/24 € HT

## Pattern (to be specified when ordering)

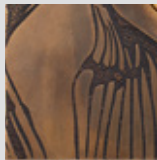

Méandres

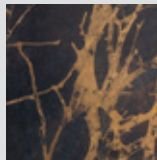

Forest Automne

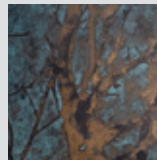

Forest Printemps



Lagon

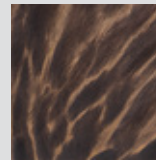

Plumes



Tissage

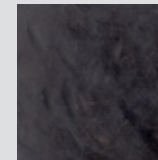

Noir Martelé



# SOL COLLECTION

## SPECIFICATIONS

### General

- Sockets with water-resistant cover
- Protection index: IP44
- Products must be installed indoors and earthed (*except for low current*)
- Cleaning only with a soft and dry duster, no product

### Covering plate

- Solid brass 10mm thick (*14mm for international*)
- With straight edges and non-visible screws
- Water-resistant cover(s)
- Finishes: Nickel, Chrome, Bronze médaille, Cuivre, Doré, Canon de fusil... (p.59)

## SIZES & BACK BOXES







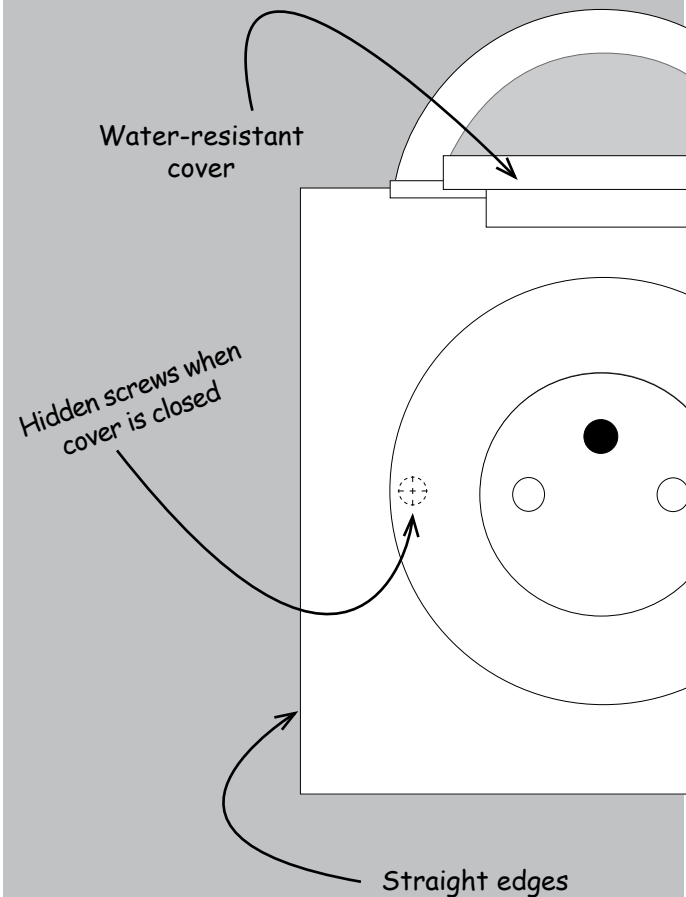

Sizes (in mm)	Back boxes
Ø100 - 100x100 - 180x100 - 180x200	Water-resistant MELJAC with installation template, for masonry only

### How to fix?



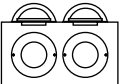

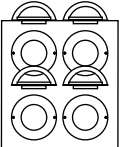

The back box + installation template set must be sealed flush with the floor.  
Then the installation template must be replaced by the covering plate with mechanisms and screws.

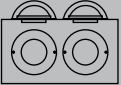

BVCert. 6012053

Diagrams	Back box colour	Size (mm)	Fittings	Reference	Cold finishes	Warm finishes	Special finishes	Shiny Gilding
		100x100x10	1 PC 2x10/16A+T	FS1000D-B0000010	602,01	632,11	722,42	866,90
			1 RJ45	FS1000D-B0000730	684,04	718,24	820,85	985,02
			1 TV outlet	FS1000D-B0001700	716,40	752,22	859,68	1 031,62
			2 TV outlets	FS1000D-B0001710	724,26	760,47	869,11	1 042,93
		Ø100x10	1 PC 2x10/16A+T	FS1003D-B0000010	596,52	626,35	715,83	859,00
			1 RJ45	FS1003D-B0000730	678,56	712,48	814,27	977,12
			1 TV outlet	FS1003D-B0001700	710,91	746,46	853,09	1 023,71
			2 TV outlets	FS1003D-B0001710	718,78	754,72	862,54	1 035,05
		180x100x10	2 PC 2x10/16A+T	FS1001D-B0000020	996,51	1 046,33	1 195,81	1 434,97
			2 RJ45	FS1001D-B0000740	1 160,58	1 218,61	1 392,70	1 671,24
			2 TV outlets	FS1001D-B0001710	1 100,99	1 156,04	1 321,19	1 585,43
			1 PC + 1 RJ45	FS1001D-B0010640	1 078,54	1 132,47	1 294,25	1 553,10
			1 PC + 1 TV outlet	FS1001D-B0058240	1 110,90	1 166,44	1 333,08	1 599,70
			1 RJ45 + 1 TV outlet	FS1001D-B0060760	1 192,93	1 252,58	1 431,52	1 717,82
		180x200x10	4 PC 2x10/16A+T	FS1002D-B0000040	1 937,37	2 034,24	2 324,85	2 789,82
			2 PC + 2 RJ45	FS1002D-B0010720	2 101,44	2 206,52	2 521,73	3 026,08
			3 PC + 1 RJ45	FS1002D-B0010660	2 019,41	2 120,38	2 423,29	2 907,95
			2 PC + 2 TV outlets	FS1002D-B0052720	2 166,16	2 274,47	2 599,40	3 119,28
			3 PC + 1 TV outlet	FS1002D-B0052660	2 051,76	2 154,35	2 462,12	2 954,54

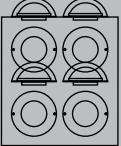
# SOL - EXPORT STANDARD SOCKETS

Diagrams	Back box colour	Size (mm)	Fittings	Reference	Cold finishes	Warm finishes	Special finishes	Shiny Gilding
		100x100x14	1 PC Schuko	FS1400D-B0000250	663,25	696,42	795,90	955,08
			1 RJ45	FS1400D-B0000730	741,83	778,93	890,20	1 068,24
			1 TV outlet	FS1400D-B0001700	774,20	812,91	929,03	1 114,84
			2 TV outlets	FS1400D-B0001710	906,34	951,65	1 087,61	1 305,13
		Ø100x14	1 PC Schuko	FS1403D-B0000250	619,34	650,31	743,21	891,85
			1 RJ45	FS1403D-B0000730	697,92	732,82	837,51	1 005,01
			1 TV outlet	FS1403D-B0001700	730,28	766,79	876,34	1 051,61
			2 TV outlets	FS1403D-B0001710	738,14	775,05	885,77	1 062,92
		180x100x14	2 PC Schuko	FS1401D-B0000260	1 085,43	1 139,69	1 302,52	1 563,02
			2 RJ45	FS1401D-B0000740	1 242,60	1 304,73	1 491,12	1 789,34
			2 TV outlets	FS1401D-B0001710	1 307,32	1 372,69	1 568,78	1 882,54
			1 PC Schuko + 1 RJ45	FS1401D-B0011480	1 164,02	1 222,22	1 396,82	1 676,18
			1 PC Schuko + 1 TV outlet	FS1401D-B0059080	1 196,37	1 256,20	1 435,65	1 722,78
			1 RJ45 + 1 TV outlet	FS1401D-B0060760	1 274,96	1 338,71	1 529,95	1 835,94
		180x200x14	4 PC Schuko	FS1402D-B0000280	2 087,97	2 192,36	2 505,56	3 006,67
			2 PC Schuko + 2 RJ45	FS1402D-B0011560	2 245,13	2 357,39	2 694,16	3 232,99
			3 PC Schuko + 1 RJ45	FS1402D-B0011500	2 166,55	2 274,88	2 599,85	3 119,82
			2 PC Schuko + 2 TV outlets	FS1402D-B0059160	2 331,07	2 447,62	2 797,28	3 356,74
			3 PC Schuko + 1 TV outlet	FS1402D-B0059100	2 198,91	2 308,86	2 638,70	3 166,44

To integrate any other mechanism, contact us.

Prices 04/24 in euros without VAT

# VOLUMES COLLECTION

## SPECIFICATIONS

### General

- Switches, bells, power sockets
- Protection index: IP20
- Products must be installed indoors and earthed
- Cleaning only with a soft and dry duster, no product

### Volume

- Solid brass
- Non-visible screws
- Finishes: Nickel, Chrome, Bronze médaille, Cuivre, Doré, Canon de fusil... (p.59)

### Control mechanisms

- Round base - Droplet lever or push button
- Chrome-plated on cold and special finishes, golden on warm finishes  
Exception: for DOME, 1920, 1951 and rectangular bell block, BP is in the same finish as the object
- Screw connection

## SIZES & BACK BOXES

Sizes (in mm)	Recommended back boxes
Macaroons - 1920 - 1930 - 1951 - Dome Square and rectangular bell blocks	LEGRAND 89246, for masonry only
Skate - Palet	LEGRAND 80051, for dry partition only

### How to fix?



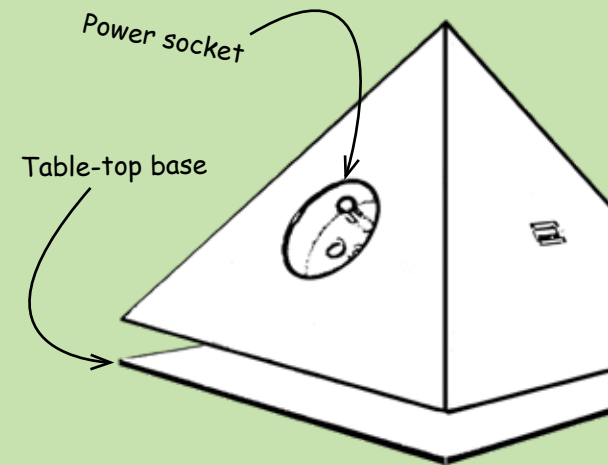
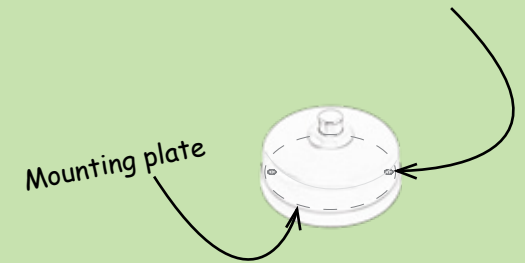









The mounting plate screws directly onto the back box. Then the volume fitted mechanisms with snaps or screws onto the mounting plate. Except for 1951, 1920, rectangular bell block and macaroon, mechanisms are on the mounting plate.



ORIGINE  
FRANCE®  
GARANTIE

BVCert. 6012053

# VOLUMES

Bells	Back box colour	Size (mm)	Fittings	Reference	Cold finishes	Warm finishes	Special finishes	Shiny Gilding
SQUARE BELL BLOCK 		L.48xl.48xH.17	1 BP 12V	FV9000Z-A1100070	254,73	267,47	305,68	366,82
1951 		L.55xl.55xH.17	1 BP 12V	FV9001Z-A1100070	505,89	531,18	607,08	728,50
DOME 		Ø55xH.36	1 BP 12V	FV9002Z-A1100070	325,01	341,27	390,02	468,02
1920 		L.94xl.52xH.20	1 BP 12V	FV9018Z-A1100070	1 179,37	1 238,34	1 415,25	1 698,30
IGULAR BELL BLOCK 		L.70xl.46xH.17	1 BP 12V	FV9004Z-A1100070	325,01	341,27	390,02	468,02
MACAROON 		Ø50xH.23	1 BP 12V	FV9005Z-A1100070	179,08	188,04	214,90	257,88







L : length

W : width





H : height

Prices 04/24 in euros  
without VAT

# VOLUMES

Volumes to fix		Back box colour	Size (mm)	Fittings	Reference	Cold finishes	Warm finishes	Special finishes	Shiny Gilding
1930			Ø58xH.32	1 V&V 230V	FV9009Z-A1100010	239,32	251,30	287,19	344,63
				1 BP 230V	FV9009Z-A1100070	234,31	246,01	281,15	337,38
SKATE			L.80xl.38xH.110	1 V&V 230V	FV9010Z-A1100010	747,87	785,27	897,45	1076,94
				1 BP 230V	FV9010Z-A1100070	742,84	779,98	891,41	1069,69
PALET			Ø80xH.19	1 V&V 230V	FV9003Z-A1100010	288,08	302,48	345,70	414,84
				1 BP 230V	FV9003Z-A1100070	284,32	298,52	341,16	409,39

## Volumes to put on

PYRAMID			B.105xH.60	1 BP 12V	FV9006Z-A1100070	1 022,88	1 074,02	1 227,46	1 472,95
			L.70xl.42xH.36	1 BP 230V	FV9007Z-A1100070	325,01	341,27	390,02	468,02
PAPER-WEIGHT			L.103xl.42xH.36	2 BP 230V	FV9008Z-A1100080	395,08	414,82	474,08	568,90
			L.106xl.42xH.36	3 BP 230V	FV9011Z-A1100090	472,74	496,37	567,30	680,76

L : length



W : width

H : height

B : base

Prices 04/24 in euros  
without VAT

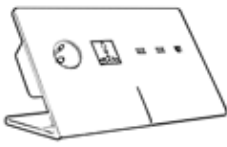
# VOLUMES

Models to fix	Size (mm)	Fittings	Reference	Cold finishes	Warm finishes	Special finishes	Shiny Gilding
Pyramid 	B:L180xI.180 H.146	4 sided power strip 2 PC + 1 RJ45 + 1 Double USB	FV9042Z-B1214300	1 114,98	1 170,72	1 337,97	1 605,56
Z 	L268xI.114 H.139	Power strip 1 PC 2x10/16A+T + 1 universal outlet + 2 USB + 1 RJ45 Cable 2 m	FV9044Z-B1302010	2 232,27	2 343,87	2 678,72	3 214,46
Pupitre 	L200xI.106 H.90	1 PC + 1 universal outlet + 1 double USB	FV9039Z-B1001500	981,54	1 030,62	1 177,85	1 413,42

Other combinations on request. (PC, RJ45, USB, V&V, BP...), contact us

L : length

W : width



H : height

B : base

Prices 04/24 in euros  
without VAT

# VOLUMES

<b>Models to put fix</b>	Size (mm)	Fittings	Reference	Cold finishes	Warm finishes	Special finishes	Shiny Gilding
CHARGEUR IPAD 	L.140xI.142 H.119	Ipad charger support Interchangeable connector compatible with Ipad and Ipad mini	FV9026Z-B0002130	977,41	1 026,28	1 172,89	1 407,47

<b>Models to put on</b>	Size (mm)	Fittings	Reference	Cold finishes	Warm finishes	Special finishes	Shiny Gilding
CALYPSO 	L.158xI.70 H.110	Power strip 2 PC 2x10/16A+T + 2 USB + 1 RJ45 Cable 2 m	FV9040Z-B1302010	836,47	878,30	1 003,77	1 204,52
TOTEM 	B:120xI.120 H.700	Power strip 4 PC 2x10/16A+T + 3 RJ45 Cable 2 m	FV9023Z-B0010800	1 144,27	1 201,49	1 373,13	1 647,76

L : length

W : width

H : height

B : base

Prices 04/24 in euros  
without VAT



# PIERROT COLLECTION

## SPECIFICATIONS

### General

- Switches and sockets
- Protection index: IP20 (*IP21 on request*)
- Products must be installed indoors and earthed
- Cleaning only with a soft and dry duster, no product

### Covering plate

- Toughened glass 4mm thick
- With chamfer and visible screws
- Choice of colour in the RAL colour chart

### Control mechanisms

- Round base - Droplet lever or push button
- Chrome-plated or golden
- Automatic connection by default, screw connection on request

## SIZES & BACK BOXES

Sizes (in mm)	Back boxes
∅98 - 80x80 - 115x80 - 80x142	Mixed MELJAC, for dry partition and masonry

### How to fix?





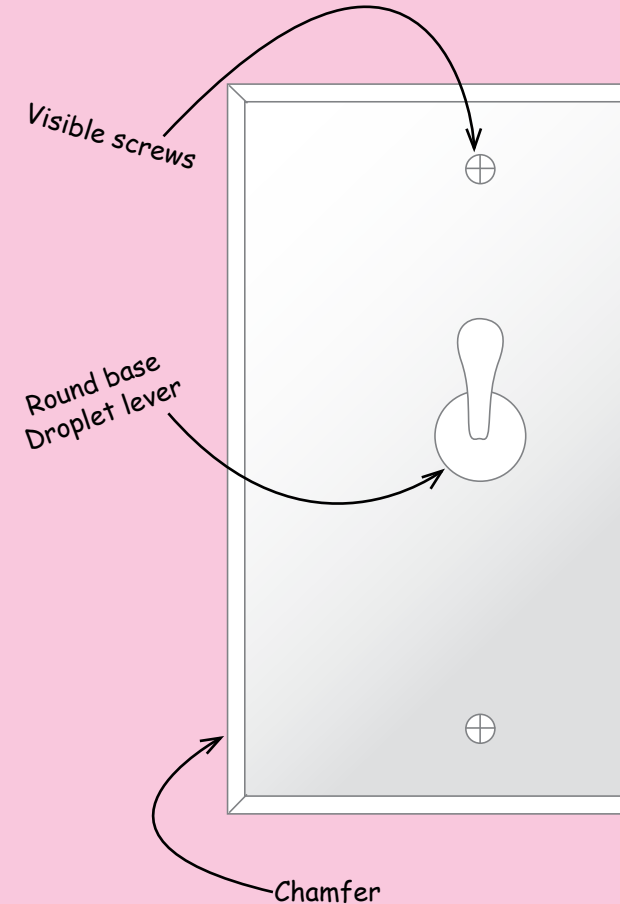

The covering plate is directly screwed onto the back box.

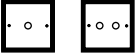

BVCert. 6012053

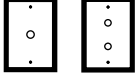
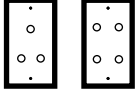

# PIERROT

Diagrams	Back box colour	Size (mm)	Fittings	Reference	Any RAL colour
	●	80x80x4	1 control element	FP4108A-A1100010	212,10
			2 control elements	FP4108A-A1100021	285,10
	●	80x80x4	1 PC	FP4108A-B0000010	208,15
			1 RJ45	FP4108A-B0000730	230,99
			1 USB	FP4108A-B0001211	285,51
 	●	Ø98x4	1 control element	FP4109A-A1100010	220,21
			2 control elements	FP4109A-A1100021	293,21
	●	Ø98x4	1 PC	FP4109A-B0000010	216,26
			2 control elements	FP4101A-A1100020	281,21
	●	80x115x4	1 control element	FP4101A-A1100010	208,21
			2 control elements	FP4101A-A1100020	281,21
	●	80x142x4	3 control elements in triangle	FP4103A-A1100031	388,12
			4 control elements	FP4103A-A1100040	461,12

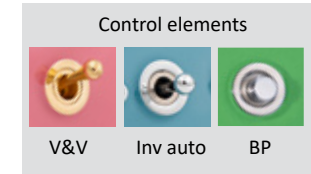

Prices 04/24 in euros  
without VAT

# PLEXIGLASS PRODUCTS

## SPECIFICATIONS

### General

- Switches and sockets
- Protection index: IP20 (IP21 on request)
- Products must be installed indoors and earthed (except for low current)
- Cleaning only with a soft and dry duster

### Covering plate

- Solid brass 3mm thick
- With chamfer and visible screws
- Transparent

### Control mechanisms

- Round base - Droplet lever or push button
- Chrome-plated or golden
- Automatic connection by default, screw connection on request

## SIZES & BACK BOXES







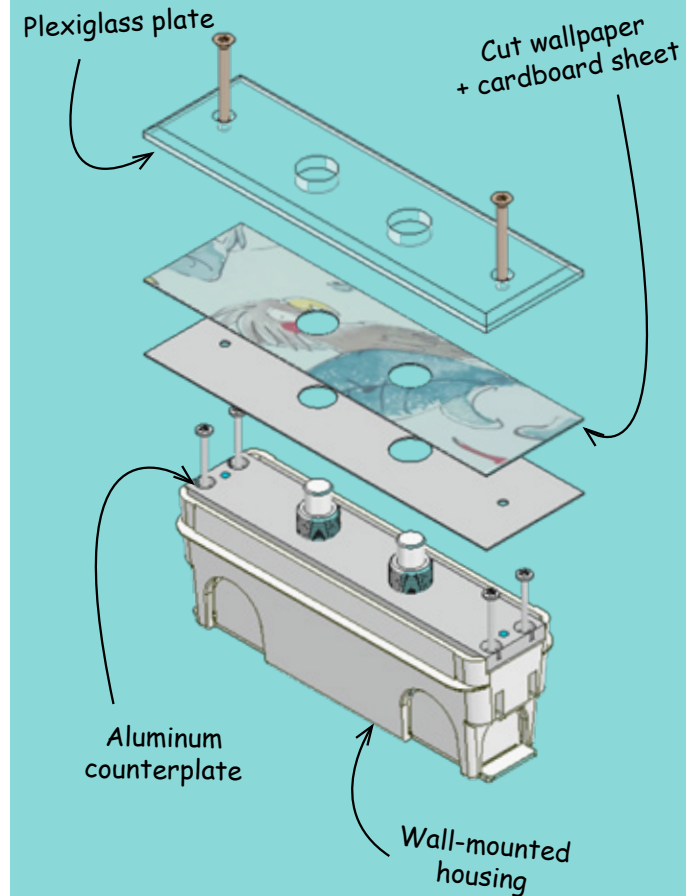
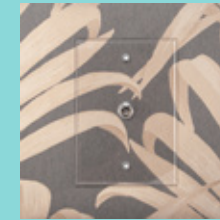



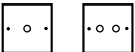



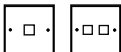

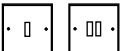



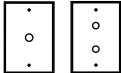





Sizes (in mm)	Recommended back boxes
80x80 - 80x115 - 80x142 - 115x80 - 142x80	Mixed MELJAC, for dry partition and masonry
38x91 - 38x133	Narrow MELJAC, for masonry only

### How to fix?

The aluminum counterplate equipped with the mechanisms screws directly onto the wall-mounted housing. The plexi cover plate is fixed onto this counterplate with 2 screws. To be fitted beforehand: the cut wallpaper and the card provided.



# PLEXIGLASS

Diagrams	Back box colour	Size (mm)	Fittings	Reference	Transparent
		80x80x3	1 control element 2 control elements	FX3008A-A1100010 FX3008A-A1100021	85,29 99,29
		80x80x3	1 PC 2x10/16A+T	FX3008A-B0000010	83,74
		80x80x3	1 RJ45 2 RJ45	FX3008A-B0000730 FX3008A-B0000740	99,20 152,70
		80x80x3	1 Type A USB socket 1 double Type A USB socket	FX3008A-B0001211 FX3008A-B0001221	175,23 183,65
	 	38x91x3 38x133x3	1 control element 2 control elements	FX3011A-A1100010 FX3010A-A1100020	85,08 102,66
		80x115x3	1 control element 2 control elements	FX3001A-A1100010 FX3001A-A1100020	92,78 114,86
		115x80x3	1 PC 2x10/16A+T	FX3000A-B0000010	102,58
		115x80x3	1 RJ45 2 RJ45	FX3000A-B0000730 FX3000A-B0000740	122,65 168,89
		115x80x3	1 Type A USB socket 1 double Type A USB socket	FX3000A-B0001211 FX3000A-B0001221	178,81 187,29
		142x80x3	2 PC 2x10/16A+T	FX3002A-B0000020	132,36
		142x80x3	1 PC + 2 control elements	FX3002A-C0010020	172,92
		142x80x3	1 PC + 2 RJ45	FX3002A-B0010710	180,71
		142x80x3	1 PC + 1 double Type A USB socket	FX3002A-B0028911	222,77

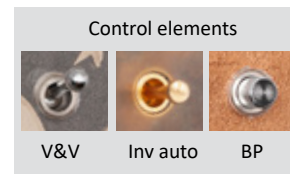

Other types of sockets available on demand

Other combinations of mechanisms on request, Please contact us

Prices 04/24 in euros without VAT

# LIMOGES CLASSIQUE COLLECTION

## SPECIFICATIONS

### General

- Switches
- Protection index: IP20 (*IP21 on request*)
- Products must be installed indoors and earthed
- Cleaning only with a soft and dry duster, no product

### Covering plate

- Limoges porcelain 3mm thick
- With straight edges and non-visible screws
- Porcelain glazed (*white colour by default, contact us for other colours*) or biscuit (*white colour only*)

### Control mechanisms

- Round base - Droplet lever or push button
- Chrome-plated or golden
- Automatic connection by default, screw connection on request

## SIZES & BACK BOXES

Sizes (in mm)	Type of back box
80x80 - 115x80 - 142x80	Mixed MELJAC, for dry partition and masonry
38x133	Narrow MELJAC, for masonry only





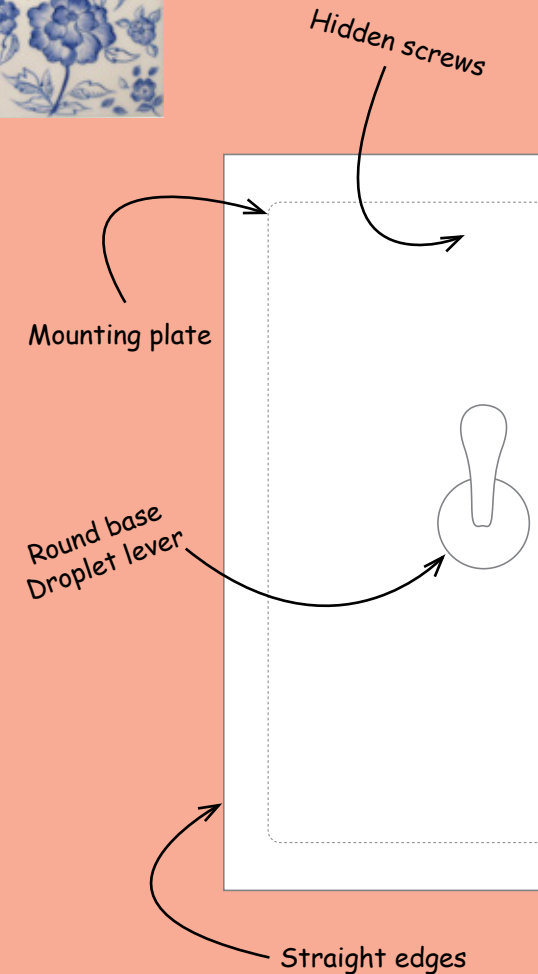
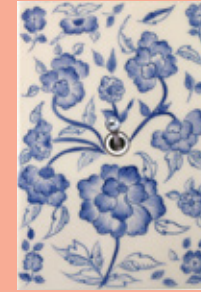



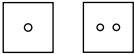

### How to fix?

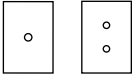
The mounting plate with mechanisms screws directly onto the back box.  
The covering plate snaps onto the mounting plate.

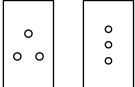

BVCert. 6012053

# LIMOGES CLASSIQUE

Diagrams	Back box colour	Size (mm)	Fittings	Reference	White colour
		80x80x3	1 control element	FL3008D-A1100010	177,08
			2 control elements	FL3008D-A1100020	269,18
		80x115x3	1 control element	FL3001D-A1100010	183,70
			2 control elements	FL3001D-A1100020	275,80
		80x142x3	3 V&V , Inv auto or BPE in triangle	FL3003D-A1100031	389,11
			3 BP in line	FL3003D-A1100090	
		80x142x3	4 control elements	FL3003D-A1100040	481,21
		38x133x3	1 control element	FL3010D-A1100010	183,70
			2 control elements	FL3010D-A1100020	275,80

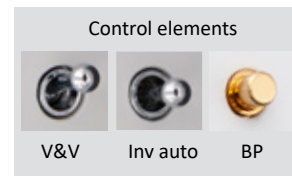

Prices 04/24 in euros  
without VAT

# LIMOGES ELLIPSE COLLECTION

## SPECIFICATIONS

### General

- Switches
- Protection index: IP20 (*IP21 on request*)
- Products must be installed indoors and earthed
- Cleaning only with a soft and dry duster, no product

### Covering plate

- Limoges porcelain 3mm thick
- With straight edges and non-visible screws
- Porcelain glazed (*white colour by default, contact us for other colours*) or biscuit (*white colour only*)

### Control mechanisms

- Elongated base - Straight lever or Seattle lever with lighting option or oblong push button
- Chrome-plated or golden
- Automatic connection by default, screw connection on request

## SIZES & BACK BOXES

Sizes (in mm)	Type of back box
80x80 - 115x80 - 142x80	Mixed MELJAC, for dry partition and masonry
38x133	Narrow MELJAC, for masonry only





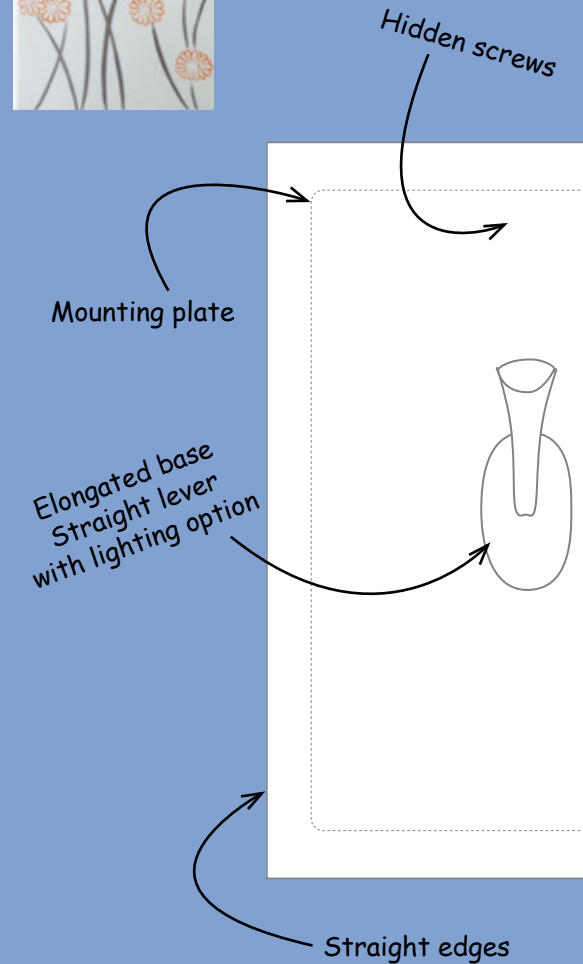
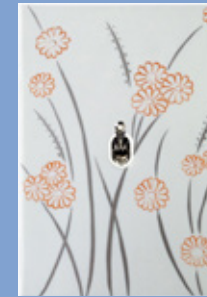



### How to fix?

The mounting plate with mechanisms screws directly onto the back box.  
The covering plate snaps onto the mounting plate.

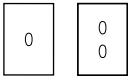

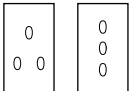
BVCert. 6012053

# LIMOGES ELLIPSE

Diagrams	Back box colour	Size (mm)	Fittings	Reference	White colour
		80x80x3	1 control element	FM3008D-A1100010	177,08
			2 control elements	FM3008D-A1100020	269,18
		80x115x3	1 control element	FM3001D-A1100010	183,70
			2 control elements	FM3001D-A1100020	275,80
		80x142x3	3 V&V , Inv auto or BPE in triangle	FM3003D-A1100031	389,11
			3 BP in line	FM3003D-A1100090	389,11
		80x142x3	4 control elements	FM3003D-A1100040	481,21
		38x133x3	1 control element	FM3010D-A1100010	183,70
			2 control elements	FM3010D-A1100020	275,80

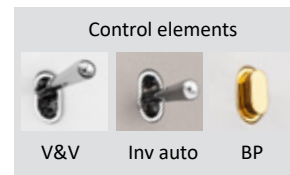

Prices for Ellipse and Seattle toggles only

JMA lever:  
26 € additional charge

Prices 04/24 in euros  
without VAT



# CRESTRON CONNECTED COLLECTION

## SPECIFICATIONS

### General

- Collection designed for direct connection to the Crestnet bus
- Push buttons
- Protection index: IP20
- Products must be installed indoors and earthed
- Cleaning only with a soft and dry duster, no product

### Covering plate

- Solid brass 3mm thick
- With straight edges and non-visible screws
- Finishes: Nickel, Chrome, Bronze médaille, Cuivre, Doré, Canon de fusil...

### Control mechanisms

- Push buttons  $\varnothing 12$  mm, 2 mm thick
- In the same finish as the covering plate
- Led feedback for each button
- Circuit board with integrated Crestron chip

## SIZES & BACK BOXES

Sizes (in mm)	Recommended back boxes
80x115	Mixed MELJAC, for dry partition and masonry





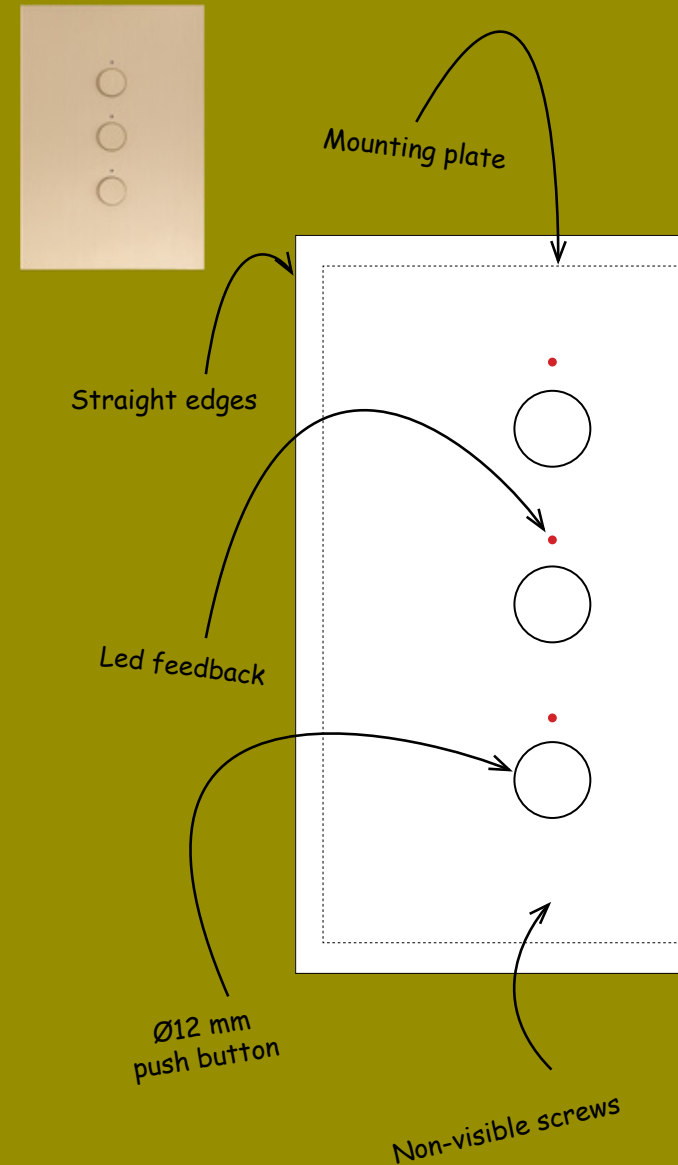



### How to fix?

The mounting plate with mechanisms screws directly onto the back box.  
The covering plate snaps onto the mounting plate.



BVCert. 6012053

# CRESTRON CONNECTED

Diagrams	Back box colour	Size (mm)	Fittings	Reference	Cold finishes	Warm finishes	Special finishes	Shiny Gilding
		80x115x3	1 BP	FO3001C-K2500410	397,97	417,86	477,56	573,07
		80x115x3	2 BP	FO3001C-K2500420	431,04	452,59	517,24	620,69
		80x115x3	3 BP	FO3001C-K2500430	464,11	487,31	556,93	668,32
		80x115x3	6 BP	FO3001C-K2500460	563,33	591,49	675,99	811,19

Prices 03/23 in euros  
without VAT

## Control elements examples with options



Fittings	Reference	Price from
2 BP	FO3001C-K2500420	431,04
Engraving 1 word	FZ9999Z-ZGR0001M99	+ 10,00
Engraving 1 additional word	FZ9999Z-ZGR1001M99	+ 10,00

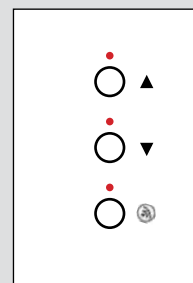

Fittings	Reference	Price from
3 BP	FO3001C-K2500430	464,11
Engraving 1 symbol	FZ9999Z-ZGR0001S99	+ 10,00
Engraving 1 additional symbol	FZ9999Z-ZGR1001S99	+ 10,00
Engraving 1 pictogram	FZ9999Z-ZGR0001P99	+ 10,00

# SPOTLIGHT COLLECTION

## SPECIFICATIONS

### General

- Recessed spotlights for false ceiling
- Protection index: IP54 CLASS II
- Products must be installed indoors in a false ceiling and earthed
- Cleaning only with a soft and dry duster, no product

### Covering plate

- Solid brass 3mm thick
- With straight edges, without screws
- Standard sizes: 58x58 mm and Ø58 mm
- Finishes: Nickel, Chrome, Bronze médaille, Cuivre, Doré, Canon de fusil... (p.59)

### Technical specifications

- Direct or asymmetric LED lighting
- Power: 230V - 5W
- Beam angle: 24°.
- Light color: warm white (2700K) or cool white (4000K)



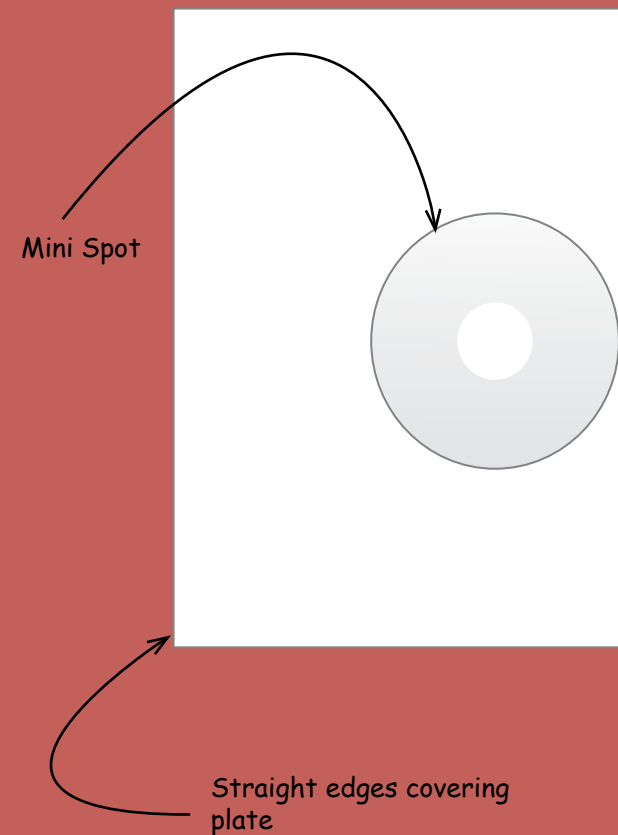

### How to fix?

The transformer is fixed in the false ceiling.  
The cover plate snaps onto the spotlight.



BVCert. 6012053

# SPOTLIGHTS

	Diagrams	Installation	Size (mm)	Fittings	Reference	Cold finishes	Warm finishes	Special finishes	Shiny Gilding
<b>DIRECT LIGHTING</b>									
SQUARE		Ceiling cut Ø45mm	58x58x3	Mini Spot 2700K-warm	FB3013C-Z5000010	145,64	152,92	174,77	209,72
				Mini Spot 4000K-cold	FB3013C-Z5000020				
ROUND		Ceiling cut Ø45 mm	Ø58x3	Mini Spot 2700K-warm	FB3014C-Z5000010	148,86	156,30	178,63	214,36
				Mini Spot 4000K-cold	FB3014C-Z5000020				
<b>ASYMMETRIC LIGHTING</b>									
SQUARE		Ceiling cut Ø45 mm	58x58x3	Mini Spot 2700K-warm	FB3013C-Z5000011	145,64	152,92	174,77	209,72
				Mini Spot 4000K-cold	FB3013C-Z5000021				
ROUND		Ceiling cut Ø45 mm	Ø58x3	Mini Spot 2700K-warm	FB3014C-Z5000011	148,86	156,3	178,63	214,36
				Mini Spot 4000K-cold	FB3014C-Z5000021				

Direct lighting



Asymmetric lighting



Both models are available with white or black interior, to specify



















Prices 04/24 in euros without VAT

# MATERIALS & FINISHES

The collections CLASSIQUE, ELLIPSE, DAMIER, ELLIOT, CANNELÉE, SOLARIS, SOL with water-resistant cover, VOLUMES, SPOTS and LAMPES are made in brass. The finishes are obtained by electrolysis.

The PIERROT collection is in toughened extra white glass. The paint is applied at the rear and highlighted by the transparency and thickness of the glass.













The LIMOGES collections are in Limoges Porcelain.

Material & fittings	Finish & description
<b>TF</b>  Brass Cold finishes <i>With chrome-plated V&amp;V, BP, BPE and Inv</i>	<b>Nickel Brossé (FA)</b>  <i>Stainless-steel aspect.</i>
	<b>Nickel Brillant (FB)</b>  <i>Mirror effect, tone slightly hotter than chrome.</i>
	<b>Microbillé Nickel (FC)</b>  <i>Sandy surface, matt varnish.</i>
	<b>Chromé Mat (FD)</b>  <i>Linear brushing. Bluish grey hue.</i>
	<b>Chromé Vif (FE)</b>   <i>Mirror with bluish sheens.</i>
	<b>Canon de Fusil Anthracite (FF)</b>   <i>Brushing. Dark grey tone, tend toward brown.</i>
	<b>Canon de Fusil Sablé (FH)</b>  <i>Granite aspect. Dark grey tone.</i>
<b>TC</b>  Brass Warm finishes <i>With golden V&amp;V, BP, BPE and Inv</i>	<b>Bronze Médaille Clair (CA)</b>   <i>Golden bronze slightly brushed. Satiny varnish.</i>
	<b>Bronze Médaille Clair Vernis Mat (CB)</b>  <i>Golden bronze slightly brushed. Matt varnish.</i>
	<b>Bronze Médaille Allemand (CC)</b>  <i>Linear brushing, medium bronze.</i>
	<b>Bronze Médaille Foncé (CD)</b>   <i>Dark brown hue.</i>
	<b>Champagne (CE)</b>   <i>Brushed brass. Matt varnish.</i>
<b>Doré Patiné (CF)</b>  <i>Gold yellow hue. Slightly brushed and satiny varnish.</i>	

Meljac can carry out special finishes on demand (example: different types of gilding, etc.) or customised.

Available finishes on collection Cannelée 

Available finishes on collection Solaris 

Material & fittings	Finish & description
<b>TS</b>  Brass Special finishes <i>With chrome or gilding controls</i>	<b>Nickel Noir Brillant (SA)</b>
	<b>Nickel Noir Mat (SB)</b>
	<b>Microbillé Chromé (SF)</b>
	<b>Argent Patiné (SE)</b>  
	<b>Cuivre Patiné (SG)</b> 
	<b>Cuivre Vieilli Bouchonné (SH)</b> 
	<b>Cuivre Satiné (SI)</b>  
	<b>Microbillé Canon de Fusil Anthracite (SM)</b>
	<b>Ebène (SQ)</b>
	<b>Canon de Fusil Belge (SP)</b> 
	<b>Laiton Vieilli Ciré (SR)</b> 
<b>D</b>  Shiny Gilding	<b>Étain Moyen (SS)</b> 
	<b>Cuivre Antique (ST)</b> 
	<b>Antique Brass NA (SU)</b> 
	<b>Black Stone Chelsea (SV)</b>
	<b>Gilding 1 shiny (1N)</b>  
	Epoxy Brass / Glass RAL colours <i>With chrome-plated or golden V&amp;V, BP, BPE and Inv</i>
<b>Limoges Porcelain</b> <i>With chrome-plated V&amp;V, BP, BPE and Inv</i>	
	<b>White Glazed (LA)</b> <i>Shiny surface</i> Other colours on request. Custom designs possible
	<b>White Biscuit (LB)</b> <i>Matt sandblasted surface</i> Custom designs possible

#### Care instructions

Metal-coated surfaces must be cleaned with a soft and dry duster only, no product.

All the products must be installed indoors.

## SAMPLE BOX & TUBES

---

Prices and delivery time upon request



The box contains the standard finishes.

\*Actual products may differ from photos

# TECHNICAL INFORMATION - GENERAL

---

## Direction of covering plate

All MELJAC products fix onto back boxes.

The screws are supplied in the same finish as plates.

By default, the axis of the cover plate screws is:

- vertical for control mechanisms (V&V, BP, BPE...)
- horizontal for sockets
- horizontal for 80x80 and Ø98 sizes

## Colour of switches

On brass, the switches are:

- chrome-plated on cold and special finishes
- golden on warm finishes

Mini mechanisms (12V) are chrome-plated only

Switches are chrome-plated or golden for glass, porcelain and plexiglass.

Accessories in the same finish as the plate:

- rotary buttons for variation
- caps of mini push buttons
- square push buttons from DAMIER collection
- bell buttons of Dome, 1951, 1920 and rectangular block
- cable lead-out (cable outputs, markings)

## Light label holder

Two shapes are available. Specify when ordering: rectangular or elliptical.

## Position of indicators, engravings (simple, complex, light...) and light label holder

By default, MELJAC selects the most harmonious position for fittings on the covering plate.

## Care instructions

Products must be installed indoors

Cleaning only with a soft and dry duster, no product

## Standards

MELJAC creations are protected in France and abroad by the copyright, the registration of models and several patents.

Probate by the norms:

- NF EN 60669-1 + A1 for switches, push buttons and reversers.
- NF C 61314 for power sockets.

For probates in process, contact us.

Following the established standard NF C 15100, each plate has to be connected to earth.

Each pattern is outfitted with a patented system of connection to earth.





Stamping CE.

Protection index: IP20 except for Sol collection IP44 and water resistant spotlights IP54 CLASS II.

**NB** : For any special requirement, please clarify and / or provide a diagram when you place an order.

## OPTIONS (ENGRAVING, TOGGLE WITH COATING)

These options are sold separately, so do not forget to specify them at the order.

	Type of option	Designation	Reference	Price
	<b>Engraving :</b> - standard font: Helvetica uppercase height 4mm - Russian standard font: Arial Narrow 4 mm - word, figure, symbol, triangle = simple symbol - pictogram = complex symbol	Engraving 1 word	FZ9999Z-ZGR0001M99	10,00
		Engraving 1 figure	FZ9999Z-ZGR0001C99	
		Engraving 1 symbol	FZ9999Z-ZGR0001S99	
		Engraving 1 pictogram	FZ9999Z-ZGR0001P99	
	Engraving triangles: per pair, on both sides of the switch (standard position: up/down)	Engraving 2 triangles	FZ9999Z-ZGR0002T99	20,00
	Laser engraving ( <i>contact us for existing designs, we can also create new</i> )	Laser engraving 1 word	- - -	Please contact us
	Silkscreen printing (words, symbols, pictograms, photographs...)	Silkscreen printing	- - -	Please contact us
	Resin ( <i>specify colour</i> )	Resin engraving 1 word	FZ9999Z-ZR00001M99	16,00
		Resin engraving 1 symbol	FZ9999Z-ZR00001S99	
		Resin engraving 1 pictogram	FZ9999Z-ZR00001P99	
	Light engraving	Light ribbon supplied in 12V or 24V (Colour of your choice)	FZ9999Z-ZGLU000199	60,00
		Additional light ribbon supplied in 12V or 24V (Colour of your choice)	FZ9999Z-ZGLU100199	
	Mirror-polished oblong base In bright chrome or gold for Ellipse lever switches	Mirror-polished	FZPLVAZ-Z0000050ZZ	37,44
	JMA lever switch subject to additional charge With oblong base	JMA lever	FZPLVAZ-Z0000040ZZ	27,04
	Additional charge for mechanism processing Processing possible on request for V&V, BP and Inv switches.	Processed mechanisms	FZPLVAZ-Z0000010ZZ	16,64
	Additional charge for black mechanism processing Processing possible on request for V&V, BP and Inv switches.	Processed black mechanisms	FZPLVAZ-Z0000010ZZ	8,51

Prices 04/24 in euros  
without VAT



## Examples of engravings

### Words

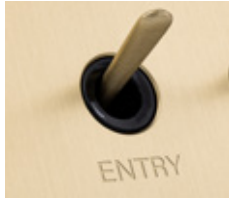

1



2



3



4

- 1 Mechanical engraving
- 2 Engraving + resin
- 3 Screen printed
- 4 Bright cut engraving

### Symbols Numbers



1



2



3



4



Bespoke engraving

## OPTIONS (LED INDICATORS, BACK-LIGHTING)

These options are sold separately, so do not forget to specify them at the order.

	Type of option	Designation	Reference	Price
	LED Indicator - Ø 3 mm - LED colour : Warm white, Blue, Pure Green, Yellow Green, Yellow, Orange, Red White cold	LED D3 30V-1mA (automation) LED D3 12V-1mA LED D3 24V-1mA LED D3 230V-1mA	FZLED0Z-Z00D303099 FZLED1Z-Z00D301299 FZLED1Z-Z00D302499 FZLED2Z-Z00D323099	16,29
	<b>Oblong light base</b> LED light strip Several colours available Interior lighting of toggle base is not available in the Cannelée collection.	LED D3 12V-1mA for Ellipse collection LED D3 24V-1mA for Ellipse collection LED D3 230V-1mA for Ellipse collection	FZLED3Z-Z00D301299 FZLED3Z-Z00D302499 FZLED3Z-Z00D323099	20,58
	Back-lighting of Damier buttons Illuminated button surround Several colours available	1 colour (12V 1mA )	FZLEDZ-Z001RT01299	27,23
		1 colour (24V 1mA )	FZLEDZ-Z001RT02499	
		1 colour (12V 1mA ) night brightness	FZLEDZ-Z002RT01299	34,21
		1 colour (24V 1mA ) night brightness	FZLEDZ-Z002RT02499	
		2 colours (12V 1mA )	FZLEDZ-Z003RT01299	37,86
		2 colours (24V 1mA )	FZLEDZ-Z003RT02499	
		2 colours (12V 1mA ) night brightness	FZLEDZ-Z004RT01299	41,50
		2 colours (24V 1mA ) night brightness	FZLEDZ-Z004RT02299	

Prices 04/24 in euros  
without VAT

## Examples of indicator options

LED indicator

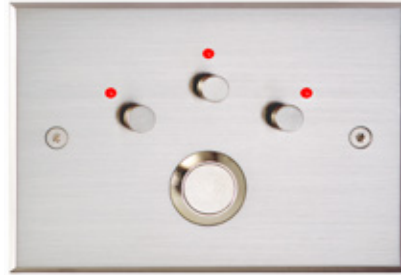

Oblong light base  
Ellipse collection









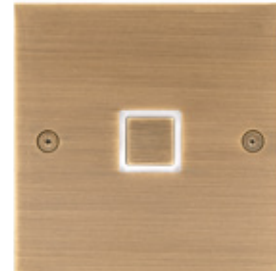





Indicator Q8 model



Backlighting  
Damier collection



# MECHANISMS CONTROLS, READING LAMPS

Type	Abbreviations	Symbole	Designation	Technical specifications
<b>Switches</b> <i>buttons and levers are chrome-plated on cold and special finishes, golden on warm finishes</i>	V&V		Toggle switch	Lever wired in one-way switch or two-way switch between 2 ignition points - automatic connection (default): 6A/250V - screw connection (on request): 6A/250V
	BP		Push button	Button wired in dimmer, one-way switch or two-way switch between 2 or more ignition points - automatic connection (default): 6A/250V - screw connection (on request): 2A/250V It MUST work with a teleruptor or a dimmer in the electrical equipment box
	BPE		Latching push button	Latching button wired in one-way switch or two-way switch between 2 ignition points - automatic connection ONLY: 6A/250V
	Inv Auto		Automatic Reverser	Three-position lever for roller shutters (2 positions + automatic return to 0) Possibility to control lighting - automatic connection (default): 6A/250V - screw connection (on request): 6A/250V Also available in manual for roller shutters only (manual return to 0)
	Mini BP		Mini push button	Button wired in dimmer, one-way switch or two-way switch between 2 or more ignition points - connection to weld: 12V It MUST work with a teleruptor or a dimmer in the electrical equipment box Silent mini BP, available on request
	square BP		Square push button	Button wired in dimmer, one-way switch or two-way switch between 2 or more ignition points - screw connection ONLY: 12V or 230V It MUST work with a teleruptor or a dimmer in the electrical equipment box
	---		Motion detector	Automatic switch - 240V - Model LEGRAND 67026 Lighting control, manual by On/Off push buttons or automatic by infrared detection
<b>Variation</b>	Var E Rotary dimmer		SCHNEIDER NUS514 model	200W- Universal. For LED, incandescent, halogen and transformer lamps. For use with a dimmer switch (push button).
			SCHNEIDER S520519 model	100W- Universal. For LED, incandescent, halogen and transformer lamps. For use with a toggle switch. A 60mm deep back box is recommended.
	Room thermostat		LEGRAND 76720 model	Room thermostat, optional hot/cold selector available Suitable for controlling heated ceilings and underfloor heating from 5°C to 30°C with an accuracy of +/- 0,5°C
	Room/floor thermostat		SCHNEIDER S520507 model	Electronic room thermostat with floor temperature limitation sensor, 2 integrated LEDs Suitable for controlling room temperature with floor heating systems, heating from 5°C to 45°C with an accuracy of +/- 0,5°C - Ambient option available
	Room and floor thermostat		SCHNEIDER S520509 model	Electronic room thermostat with floor temperature limitation sensor, with touch screen and pilot wire Suitable for controlling room temperature with floor heating systems, heating from 5°C to 45°C with an accuracy of +/- 0,5°C
<b>Reading lamp</b>	---	---	Reading lamp	Wall lamp : - Lighting (provided): 1,4 W LED (Tulipe model: 110 lumens, Roseau model: 150 lumens), supplied by a 350 mA electronic converter - Beam: 60° for Roseau model and 45°, 60° (default) or 110° for Tulipe model - Lampshade : straight or beveled cone for Tulipe model - Flexible arm : 25 cm with or without a 135° bend connection
			Tactile reading lamp	- Lighting : LED 3500 K, from 47,1 to 66,9 lumens - Variable luminous intensity - Flexible arm : 25 cm with or without bend a 135° connection

## Mechanisms provided (since 2010)

Automatic connection  
(by default)



Screw connection  
(on request)



## Former mechanism

Screw connection  
only



### Connection

Use rigid cable of section 1,5 mm<sup>2</sup> stripped on 13 mm for automatic connection or 10 mm for screw connection



V&V  
wired in ON/OFF function

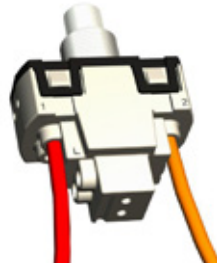

BP  
wired in ON/OFF function





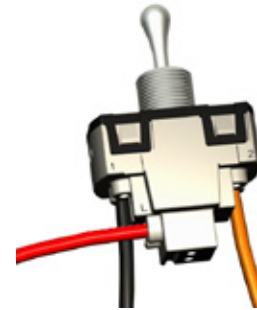















BPE  
wired in two-way function



Inv Auto

# MECHANISMS OUTLETS (high voltage, low voltage)

Type	Abbreviations	Symbole	Designation	Technical specifications
Power socket	PC		Power socket	French model 2x10/16A+T with child security Sockets are black by default, off-white on request
	Universal PC		Wonpro power socket	Wonpro R4S model. Universal socket 2x16A+T with child security Sockets are black by default, off-white on request Prior agreement from a control authority required
	PC Schuko		Schuko power socket	German / european model 2x10/16A+T with child security Sockets are black by default, off-white on request
	PC Bipasso		Bipasso power socket	Italian model 2x10/16A+T with child security
	PC Unel		Unel power socket (Schuko + Bipasso)	European model 2x10/16A+T with child security Sockets are black by default, off-white on request
Phone/Data Connection	RJ45 without PE		Data socket without white label holder	Model SCHNEIDER RJ1772XB12 Category 6a FTP socket
Connexion Audio/Vidéo	DIN base		Audio connector	3-pin female base (male plug on request)
	Speaker		Speaker socket	Model LEGRAND 67311 - Terminal with push/release connectors
	Flush RCA socket		Audio/video connector	D-serie female base
	HDMI		HD audio/video connector	Female/female connector
TV Connection	TV-FM-SAT		TV, radio and satellite antennas socket	
	TV outlet		TV antenna socket	
IT-connection	USB power		USB A power socket	- Simple : Model LEGRAND 77591 - 7,5W - Double : Model LEGRAND 67462 - 15W
			USB C power socket	- Simple : Model LEGRAND 77589 - 7,5W - Double : Model LEGRAND CM0158 - 30W
			USB A+C power socket	Model NIKO 420-00513 - 17,5W
Others	---		Shaver socket	Model VIMAR 16290 It can work with european, american, british and australian plugs
	---		Cable outlet	Specify diameter
	---		Cable lead-out	Specify diameter (12mm max)

PC or PC Schuko : automatic connection



Use rigid cable of section 2,5 mm<sup>2</sup>  
stripped on 13 mm



How to extract cable

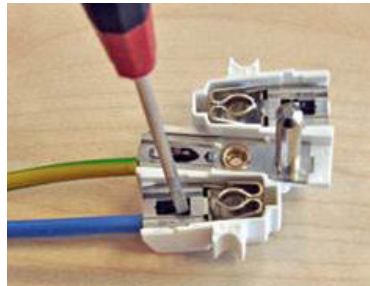

Renovation

Since 2016, MELJAC products are fitted with  
a new socket mechanism (France or Schuko)  
that takes less space.

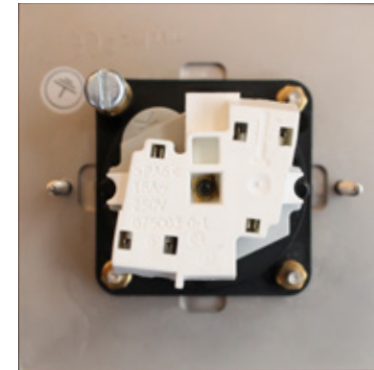

CLASSIQUE collection plates 80x80mm can be  
mounted on most of the existing back boxes  
in renovation.

# BACK BOXES

All MELJAC products are fixed onto back boxes. Screws are supplied in same finish as plates.

MELJAC designs its own back boxes and continues to develop new series in line with its ranges.

Type of back box	Back box overview	Back box colour	Reference	Compatible with...	Overall dimensions (L. x W. x D. in mm)	Price
<p>Mixed MELJAC back boxes for CLASSIQUE, ELLIPSE, DAMIER, SOLARIS and PIERROT collections</p> <p>Mixed models are used in masonry and dry partition with an additional kit to maintain back box into the wall.</p>			CBBOICZ-Z080800299	Plates 80x80, 84x84 and Ø98 mm	71x69x50 Screws interaxis 60 mm	4,28
			CBBOICZ-Z115800199	Plates 115x80 and 120x84 mm	97x69x50 Screws interaxis 88 mm	4,61
			CBBOICZ-Z142800199	Plates 142x80 and 144x84 mm	128x69x50 Screws interaxis 117 mm	5,01
			CBBOICZ-Z205800199	Plates 205x80 and 210x84 mm	190x69x50 Screws interaxis 180 mm	6,26
			CBBOICZ-Z267800199	Plates 267x80 mm	252x69x50 Screws interaxis 242 mm	8,26
Kit for back box adaptation in DRY PARTITION		- - -	CBBOICZ-Z0MELKIT99	Plates 80x80, Ø98, 115x80, 142x80, 205x80 and 267x80 mm		1,65
Partition to separate the high and low currents	- - -	- - -	CBAENT-MEL50500099	Plates 142x80, 205x80 and 267x80 mm		0,71
<p>Narrow MELJAC back boxes for CLASSIQUE, ELLIPSE AND VOLUMES collections</p> <p>Designed for narrow plates, they may be used in masonry only and must be sealed.</p>			CBBOICZ-Z091380199	Plates 38x91 mm and doorbell 1920	76x37x45 Screws interaxis 66 mm	4,22
			CBBOICZ-Z133380199	Plates 38x133 mm	118x37x45 Screws interaxis 108 mm	4,36
			CBBOICZ-Z175380199	Plates 38x175 mm	160x37x45 Screws interaxis 150 mm	4,50

L : length















W : width

D : depth

Prices 04/24 in euros  
without VAT



# BACK BOXES

Type of back box	Back box overview	Back box colour	Reference	Compatible with...	Overall dimensions (L. x W. x D. in mm)	Price
<b>Back boxes for VOLUMES and CANNELÉE collections</b> LEGRAND 80051, for dry partition only. LEGRAND 80052, for dry partition only. LEGRAND 89246, for masonry only, <b>must be sealed.</b>			CBBBOIL-8005100099	Oval, hexagonal and octagonal plates, Skate, Palet Plates 80x80 of the Cannelée collection	Ø 67xP.50 mm	2,71
			CBBBOIL-8005200099	Plates 151x80 of the Cannelée collection	Ø 2x67 xP.50 mm	11,43
			CBBBOIL-8924600099	Plates Ø 56 mm and 56x56 mm, Macaroons, 1930, 1951, Dome, square and rectangular bell blocks	Ø 47xP.40 mm	8,06
<b>Water-resistant MELJAC back boxes with installation template for SOL collection</b> To install the products with water-resistant cover, installation templates corresponding to the final dimensions of the plates are provided. They are mounted on back boxes for masonry only and <b>must be sealed.</b>  The templates allow perfect placement of the back box so that the plate lies flush with the floor.			CBBOISZ-Z10D100199 CBBOISZ-Z14D100199	Plates Ø 100x10 mm Plates Ø 100x14 mm	Ø 100x60 Ø 100x64	6,60
			CBBOISZ-Z10L100199 CBBOISZ-Z14L100199	Plates 100x100x10 mm Plates 100x100x14 mm	100x100x60 100x100x64	6,60
			CBBOISZ-Z10L180199 CBBOISZ-Z14L180199	Plates 180x100x10 mm Plates 180x100x14 mm	180x100x60 180x100x64	9,98
			CBBOISZ-Z10L180299 CBBOISZ-Z14L180299	Plates 180x200x10 mm Plates 180x200x14 mm	180x200x60 180x200x64	19,98

## Renovation

Some models of CLASSIQUE and ELLIPSE collections are compatible with the existing standard back boxes (please contact us). MELJAC also proposes bespoke products for an installation on other back boxes.

Prices 04/24 in euros  
without VAT

## NON-VISIBLE SCREWS OPTION

The screwless option adds a supplement corresponding to the price of the backplate that needs to be fixed to the back box.  
This option is only available for the CLASSIQUE and ELLIPSE collections. It is not available for the other brass collections which are already screwless (DAMIER, ELLIOT, CANNELEE, SOL and VOLUMES) or for the collections made of other materials (PIERROT, PLEXIGLASS and LIMOGES).

Type of back box	Compatible with...	Reference	Cold finishes	Warm finishes	Special finishes
Mounting plates for MELJAC back boxes	Plates 80x80	AA3008Z-Z0001MOD	26,00	27,30	31,20
	Plates 80x115	AA3000Z-Z0001MOD	26,00	27,30	31,20
	Plates 80x142	AA3002Z-Z0001MOD	32,24	33,85	38,69
	Plates 205x80	AA3004Z-Z0003MOD	38,48	40,40	46,18
	Plates 267x80	AA3006Z-Z0004MOD	44,72	46,96	53,66
	Plates 38x91	- - -	26,00	27,30	31,20
	Plates 38x133	- - -	26,00	27,30	31,20
	Plates 38x175	- - -	32,24	33,85	38,69
Mounting plates for LEGRAND back boxes	Simple	AA3008Z-Z1001MOD	32,24	33,85	38,69
	Double	AA3025Z-Z0002MOD	42,64	46,96	51,17
	Triple	AA3031Z-Z0003MOD	53,04	55,69	63,65
	Quadruple	AA3038Z-Z0004MOD	63,44	66,60	76,13

\*to be added to the price of the plate and back box

Prices 04/24 in euros  
without VAT

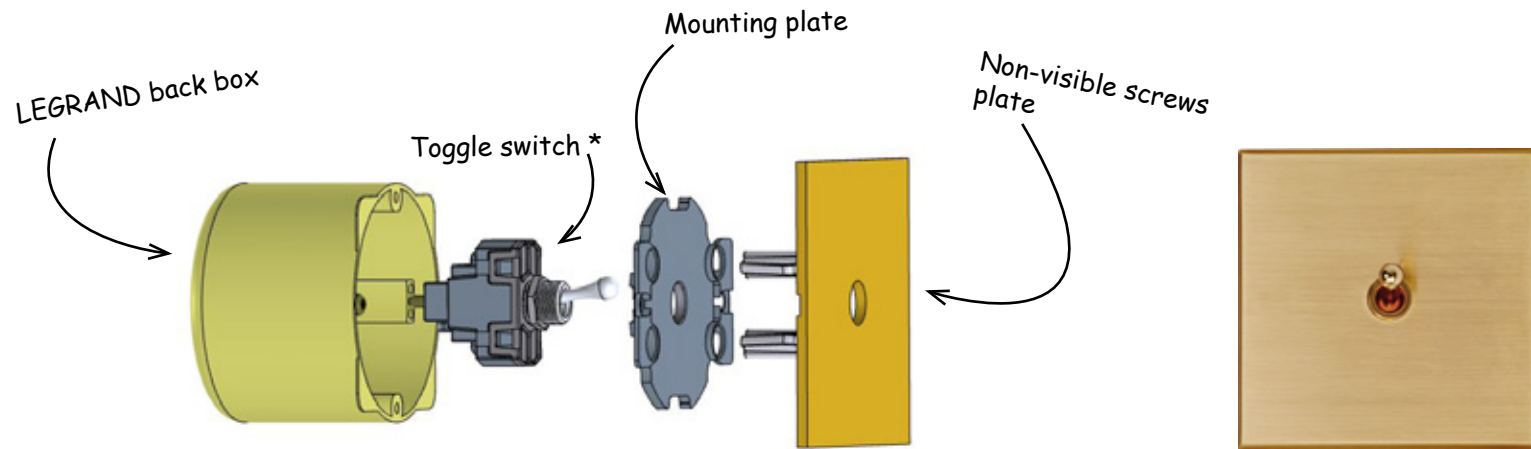
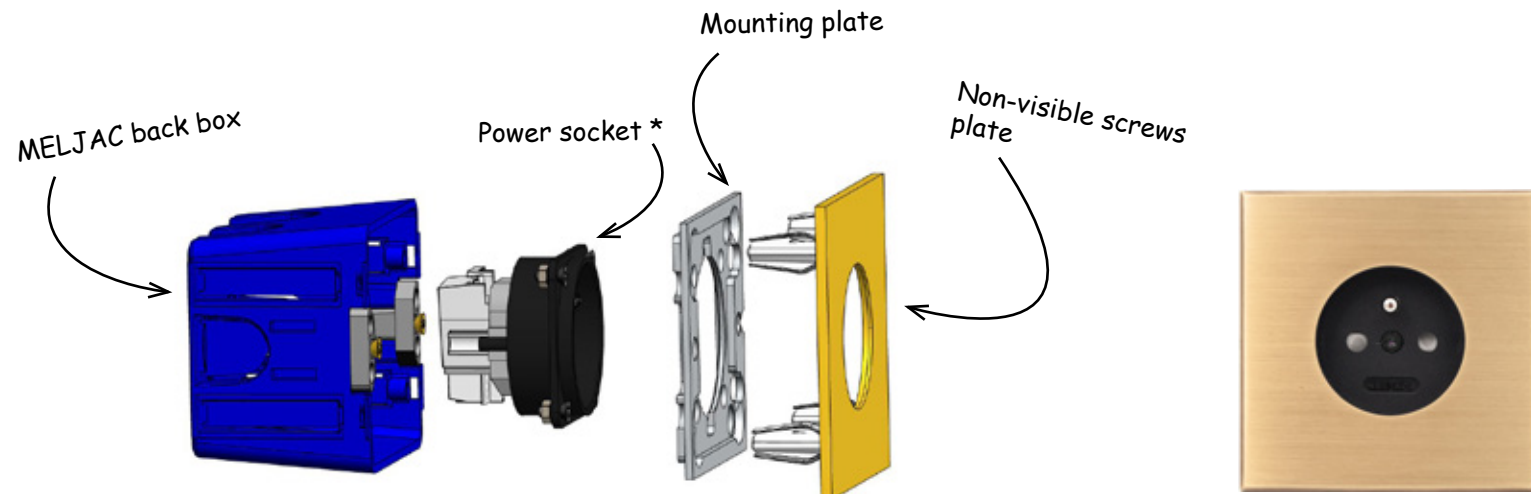

\* Example (other mechanisms on demand)

# TERMS & CONDITIONS OF SALE

---

## I. MAIN CLAUSE

These General Terms and Conditions apply to all sales of our products, and prevail over any and all other terms and conditions of purchase, unless otherwise expressly agreed and signed in writing by ourselves.

They were updated on 1 October 2022, supersede the previous Terms and Conditions of a prior date and may be changed without prior notice.

## II. CONFIDENTIALITY

All designs, plans, drawings or documents which are provided or sent by MELJAC remain the property of same; in any case and for any reason, they may not be disclosed to third parties, under penalty of damages.

## III. CONTRACT FORMATION

An order may only be registered and give rise to a MELJAC purchase order if:

- (i) It occurs subsequent to the issuance of a quotation: it must be approved by returning it to the MELJAC sales department dated, signed and marked “good for agreement” (mandatory for private customers). Our quotations are valid for 2 months from date of issue.
- (ii) It is duly written in the form of a Purchase Order on letterhead for companies, with the name and signature of the requester.
- (iii) All items necessary for production have been supplied to the MELJAC sales department:
  - a. Feasibility and diagrams of engraving dated and signed with the words “good for agreement” appearing thereon
  - b. Equipment to be adorned in the case of an order for a plate as casing for equipment not supplied by MELJAC

**Manufacturing lead times run only from the time when points (i), (ii) and (iii) are observed and the order is accepted by MELJAC.**

This order implies acceptance of the prices in effect on the order date, and the terms of any rebate or trade discount granted.

For any order giving rise to a production order, **no change or cancellation** may be made **after 48 hours**. Within this time span we accept only 2 changes to the same order, which corresponds to one change every 24 hours.

**After 48 hours** of issuance of the initial order, no change or cancellation may be considered and a new quotation will need to be approved prior to conversion into a **new order**. This new order will naturally be reintegrated into the production priorities as of the new order date.

Similarly, no goods may be returned unless specifically agreed with the person in charge of the commercial offer.

## IV. DELIVERY

Owing to the craftsmanship involved in manufacturing the order, the average lead times are provided for general guidance purposes only and may not constitute a binding contractual agreement: a minimum of between 6 and 8 weeks for standard equipment in certain collections (Classique collection); special equipment will be assessed on a case by case basis. Quotations provide an approximate shipping date in weeks and this date may be confirmed or reviewed when the purchase order is sent.

We use our best endeavours to meet the shipping dates indicated. Any delays do not entitle the buyer to cancel the sale, refuse the goods, or claim damages. In any event, we may not be held liable:

- (i) If the payment terms specified are not adhered to
- (ii) If information necessary for the execution of orders is not provided to us in good time
- (iii) In the event of a delay by our own suppliers, unforeseen events, etc.

In such conditions, no penalty for late shipment may be accepted by MELJAC, except in specific cases and subject to prior written agreement.

# TERMS & CONDITIONS OF SALE

---

## V. RETENTION OF TITLE

MELJAC retains ownership of goods sold until effective payment of the full price in principal and accessories.

Failure to pay any one of the instalments may lead to repossession of the goods concerned by MELJAC. After 6 months from order execution and the first reminder to pay the remaining balance on the order, MELJAC shall proceed with order cancellation, reintegration (where possible) of the products/components to stocks and shall retain the deposit already paid by way of compensation.

## VI. PRICES – TERMS OF PAYMENT

**The prices set by MELJAC are exclusive of VAT and in euro;** their term of validity is clearly indicated.

**Shipping fees are not included in the price** (prices are quoted EXW (ICC INCOTERMS 2000): Ex Works).

MELJAC reserves the right to amend them without notice at any time, in particular due to raw material price fluctuation.

**An initial minimum payment of 30% of the full order price will apply for all firm orders placed. Payment will be 100% of the full order price in the case of orders equal to or under 500 euro including VAT.**

Payment of the remaining balance shall be made before order shipment or collection, according to the shipping terms specified on order confirmation.

Any other payment terms shall be mentioned beforehand on a contractual document issued by MELJAC and signed by the client. In the event of any change to the legal or financial situation of the client, we reserve the right, even after partial execution of the order, to require guarantees to continue its execution.

The terms of payment shall be endorsed and accepted when the order is placed, including payment of the deposit, under penalty of delaying order registration.

Any delay in the settlement of a previous order may halt any new order or suspend any existing order until complete settlement of the requester's account, without prejudice to any other course of action.

In the event of postponed shipment through the client's fault, storage charges may be invoiced.

## VII. GUARANTEE

MELJAC's guarantee covers its products against any defect in design, material and/or workmanship for a period of 24 months under the following conditions:

- Any apparent defect must imperatively be reported to MELJAC upon receipt of the goods;
- Any malfunction must be revealed or be reported to MELJAC within a maximum period of 7 days as from shipment, it being specified that the product must be used in accordance with its intended purpose and nature.

Upon expiry of the above periods, the buyer shall no longer be entitled to enforce the guarantee. This period of 24 months runs from the shipment date.

The client shall be required to inform MELJAC by providing explanations about the defect encountered, illustrated with photos. MELJAC may, if necessary, request that the product in question be returned to its premises for inspection.

It is understood that the above guarantee is excluded in the following cases:

- (i) in the event of installation that does not comply with professional standards and practices or the technical instructions (where such instructions exist), and in the event of abnormal, improper or inappropriate use of the product given its nature and/or contractual purpose;
- (ii) in the event, after shipment, of lack of/defective storage and/or misstorage, maintenance, conservation or custody required by the nature and/or contractual purpose of the product, in particular climatic conditions, hydrometric conditions, temperature, light, poorly protected warehouse (this list is not limitative).

The client also acknowledges being informed that surface treatments are likely to change over time according to the conditions referred to in subparagraph (ii) above. **Such potential changes are not guaranteed.**

# TERMS & CONDITIONS OF SALE

---

**MELJAC's liability is expressly limited to the guarantees and reservations defined above and may under no circumstances be sought or engaged due to incidents and/or accidents caused to people or items in the event of abnormal installation and/or use or installation or use that is ill-suited to the purpose or nature of our products. Our liability is in any event financially limited to the amount (VAT excluded) of the product(s) or materials under investigation.**

The above contractual guarantee shall in no way be construed as limiting the French legal guarantees.

## **VIII. RESOLUTIVE CLAUSE**

In the event of non-execution of their obligations by either party, the contract governed by these General Terms and Conditions of Sale shall be terminated ipso jure to the benefit of the other party, without prejudice or damages that might be claimed by the defaulting party.

Termination shall take effect 15 days after written notice thereof has been sent by registered post with acknowledgement of receipt and remains unsuccessful.

## **IX. ATTRIBUTION OF JURISDICTION**

**Any dispute regarding the conclusion, execution or interpretation of the contract and sales which could not be resolved amicably shall be referred to the exclusive jurisdiction of the Commercial Court of Paris, which is expressly granted jurisdiction.**

## **X. ACCEPTANCE AND OBJECTION**

The present General Terms and Conditions of Sale constitute an element of contract.

MELJAC clients shall be deemed to have accepted such Terms and Conditions unless reservations are made at the time of the order.



**Showroom & Headquarter**

3 rue de la Procession  
75015 PARIS  
FRANCE

☎ : +33 (0)1 40 61 08 43  
📠 : +33 (0)1 40 61 08 46  
✉ : france@meljac.com

**Showroom Rhone-Alpes Region**

5 rue Charles DULLIN  
69002 LYON  
FRANCE

☎ : +33 (0)4 78 38 37 72  
📠 : +33 (0)4 78 38 09 64  
✉ : lyon@meljac.com

**Export Department**

☎ : +33 (0)1 47 34 21 42  
📠 : +33 (0)1 47 34 21 46  
✉ : export@meljac.com

**Other services**

☎ : +33 (0)1 70 08 06 30  
✉ : yachting@meljac.com  
✉ : hospitality@meljac.com

Distributed by:

[www.meljac.com](http://www.meljac.com)



@maisonmeljac